



Barracuda Industrial Security

Securing the internet of things

Product Overview

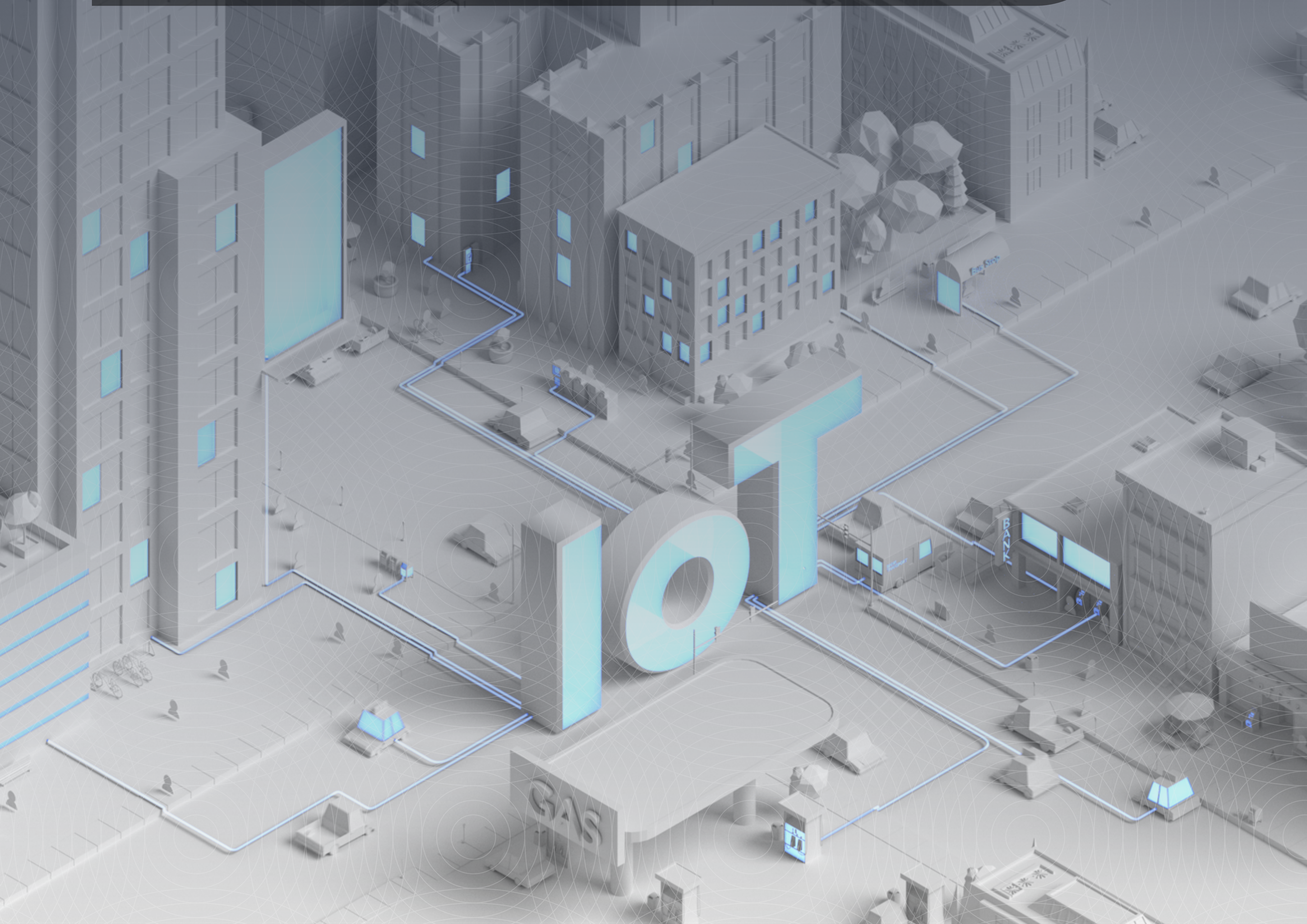

Table of contents

ABOUT BARRACUDA NETWORKS	3
SECURING THE INTERNET OF THINGS WITH BARRACUDA	4
HOW DOES IT WORK?	5
Barracuda Secure Connector (SC)	5
Barracuda Firewall Control Center	5
Outcome	5
FOOD FOR THOUGHTS AROUND IOT SECURITY	6
IoT security in retail.	6
IoT security in health care	6
IoT security in the public sector	7
IoT security in transportation.	7
IoT security in energy	7
General use cases	7
Unique digital identity	7
Predictive maintenance	7
HARDWARE FACTS	8
Model comparison	8
Secure Connector FSC20	9
Secure Connector FSC21	10
Secure Connector FSC24B	11
Secure Connector FSC25B	12
Secure Connector FSC30	13
Secure Connector FSC31	14
Secure Connector FSC34	15
Secure Connector FSC35	16
Wi-Fi, 3G, and 4G specifications.	17
CONNECTIVITY AND CENTRAL ADMINISTRATION	18
Barracuda CloudGen Firewall	18
Barracuda Firewall Control Center	19
Lifecycle management	19
Scalable deployment	20
Cloud deployment	20
Zero-touch deployment.	20
Enterprise- and service provider licensing.	20
Comparison of Barracuda Firewall Control Center models	20

SUPPORTED SCADA PROTOCOLS.	21
S7 sub-protocols	21
S7+ sub-protocols	22
IEC 60870-5-104 sub-protocols	23
IEC 61850 sub-protocols.	23
DNP3 sub-protocols	24
MODBUS sub-protocols	24
AVAILABLE SUBSCRIPTIONS	25
Availability matrix.	25
Energize Updates	25
Advanced Threat Protection.	26
Malware Protection	26
Warranty Extension.	27
Instant Replacement	27
Comparison “Warranty Extension - Instant Replacement”	27
Premium Support.	28
ORDERING INFORMATION	29
DIN rail compatible appliances	29
APPENDIX I - CERTIFICATES	30
CE Declaration of Conformity	30
APPENDIX II - APPLIANCE MEASUREMENTS	31
Secure Connector FSC20	31
Secure Connector FSC21	32
Secure Connector FSC24B	33
Secure Connector FSC25B	34
Secure Connector FSC30	35
Secure Connector FSC31	36
Secure Connector FSC34	37
Secure Connector FSC35	38
APPENDIX III - FEATURES AND CAPABILITIES.	39
Barracuda Secure Connector and Barracuda CloudGen Firewall	39
Advanced Remote Access.	46
Barracuda Firewall Control Center	47
Central software update.	48
APPENDIX IV - USEFUL LINKS.	50

About Barracuda Networks

Barracuda Networks provides cloud-connected security and storage solutions that simplify IT. These powerful, easy-to-use, and affordable solutions are trusted by more than 200,000 organizations worldwide. Barracuda's expansive product portfolio delivers protection against threats targeting email, web, and network intrusions, as well as products that improve application delivery, network access, message archiving, backup, and data protection, on-premises or in the cloud.

Barracuda's high-value, subscription-based IT solutions provide end-to-end network and data security that helps customers address security threats, improve network performance, and protect and store their data.

Barracuda's international headquarters are in the heart of northern California's Silicon Valley.



Securing the internet of things with Barracuda

The tremendous number and variety of devices coming online with the rise of the Internet of Things (IoT) gives cybercriminals a target-rich environment. Managing and securing the ever-growing number of internet connected remote devices is posing new challenges to organizations of all sizes.

Consider the scale and the potential cost of getting security wrong: Today, ATMs, vending machines, HVAC equipment, cold storage and refrigeration systems, installations for water and sewage treatment, public transportation, armored cars, even traffic control, and digital signage equipment are connected to the internet. By definition, each and every one of them is exposed to increasingly sophisticated cyber threats.

But it is not just about the scale of IoT deployments. Just think about diagnosis devices in hospitals like magnetic resonance tomographs. These devices utilize old software and not up-to-date operating systems. Especially, when dealing with such devices requiring old, unpatchable operating systems (e.g., Windows 95, etc.), securing the access is essential.

Barracuda offers highly secure, ultra-small, and rugged devices for advanced network security, encrypted communications, and cost-effective connectivity. Full integration into the Barracuda Firewall Control Center architecture guarantees hassle-free centralized management for tens of thousands of remote devices.

- Secure Digital Transformation for Internet of Things and connected industrial devices
- Economical and secure rollout with Zero Touch Deployment
- Highest level of scalability to connect and protect thousands of devices
- Enforcement for all common SCADA protocols
- Permanent and on-demand connectivity for IT and OT
- Secure Remote Access to IoT, industrial devices, and facility management



Figure 1 - Secure Connector 2 appliance with WiFi and 4G antennas

How does it work?

Securing an IoT deployment with Barracuda involves three essential components:

Barracuda Secure Connector (SC)

This hardware appliance is deployed right in front of the IoT device or IoT network segment that needs to be secured.

Besides basic firewall capabilities, SC unfolds full TINA VPN compatibility to create highly reliable high-performance and high-security VPN connectivity.

Each Secure Connector can be centrally managed including edge intelligence to pre-evaluate data or optimize remote maintenance processes.

Barracuda CloudGen Firewall

Barracuda CloudGen Firewall acts as connection hub and adds full next-generation firewall capabilities to the data stream of up to 2,000 SC appliances per CloudGen Firewall deployment.

Barracuda Firewall Control Center

This management solution enables administrators to manage and configure security, content, traffic management, and network access policies from a single interface. Template-based configuration and globally available security objects enable efficient configuration across thousands of locations.

Outcome

Securing a IoT infrastructure the Barracuda way, not just simply protects the internet-connected devices. It also solves connectivity and administrative issues and makes the maintenance of such highly dispersed setups a breeze.

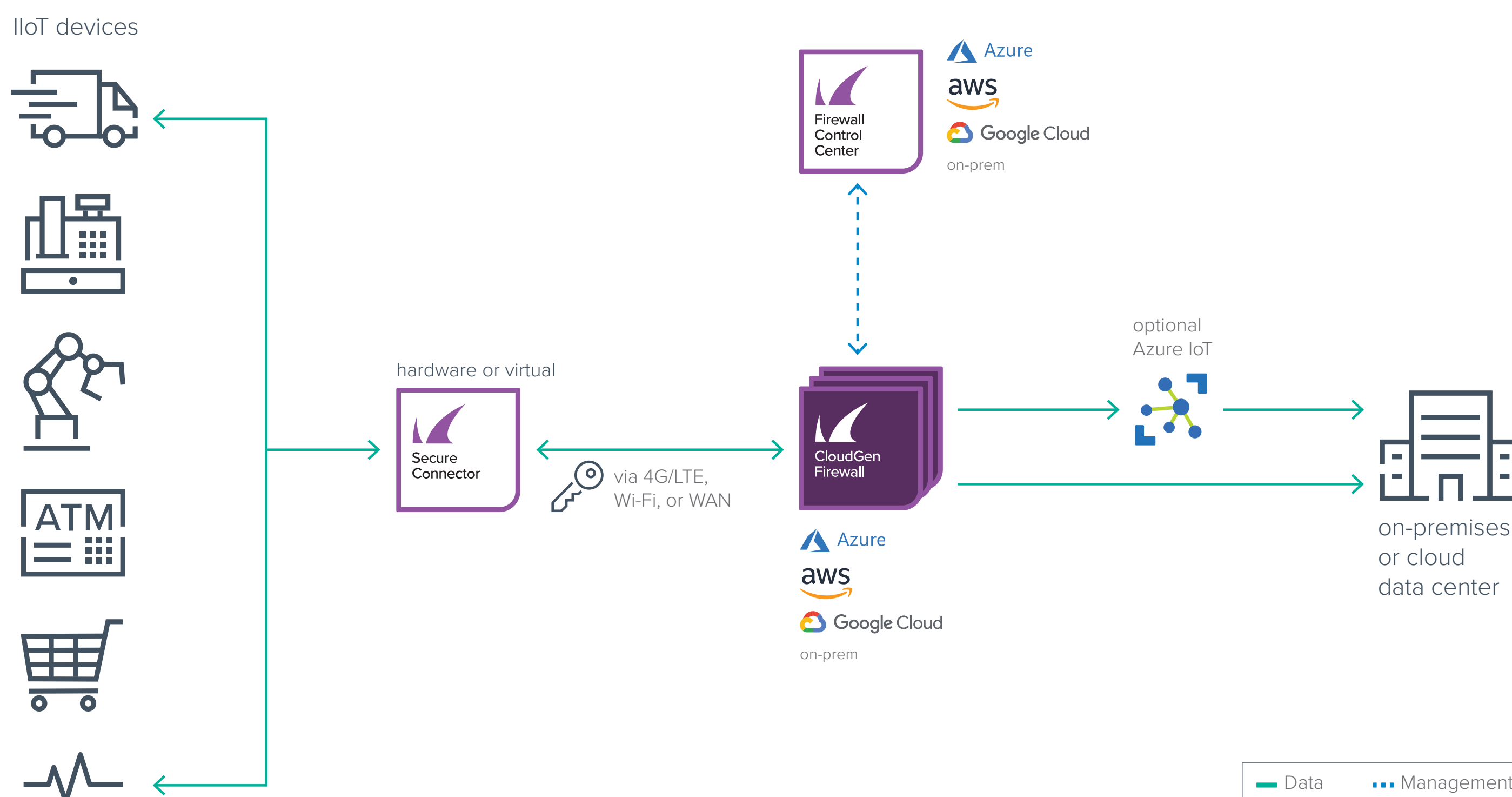

Figure 2 - Barracuda Security for IoT deployments

Food for thoughts around IoT security

The Barracuda approach enables various approaches in terms of highly secure environments. In the following, you find some use cases around this topic.

IoT security in retail

Retail IoT networks usually come with a wide area of IoT devices like cash vending machines, industrial refrigeration systems, air conditioning, surveillance cameras and more.

At the same time as these devices require connection to the internet or a data center, it might be necessary to run analysis tool directly on the Secure Connector. For this reason, all SC appliances provide a Linux container that can hold custom applications. To ease administration of this edge-computing functionality, this Linux container can be equipped and maintained directly via the Barracuda Firewall Control Center.

Several SC appliance models also come with integrated WiFi and/or 4G modem. This allows to connect the appliance via WiFi or to use a 4G uplink if no WiFi or LAN access is available on the shop floor.

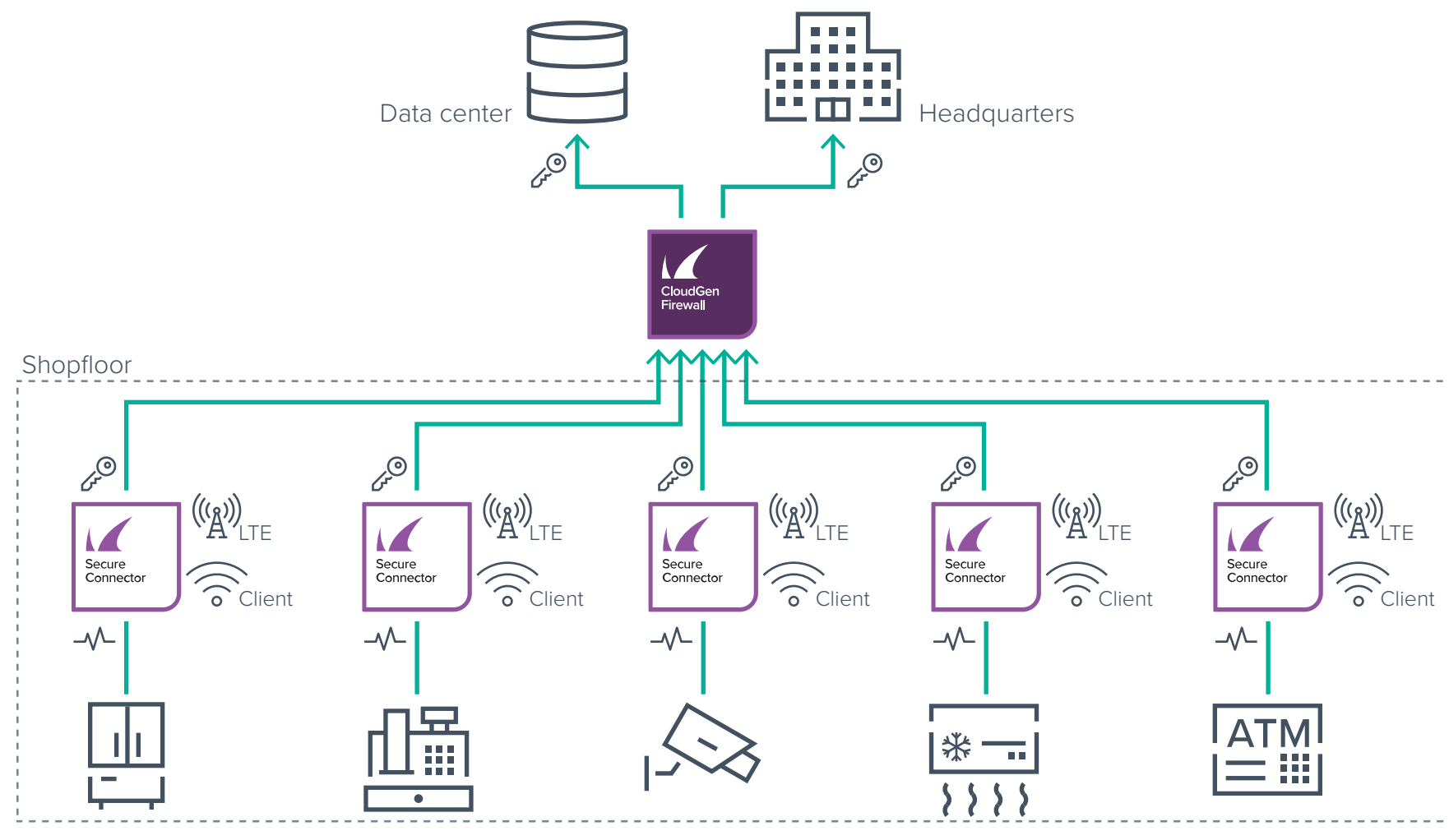

Figure 3 - IoT security in retail

IoT security in health care

Especially in health care the possibility of running outdated operating systems is very high. There is no way to overcome this potential security hazard as devices like MRI need certain drivers that may have been optimized for an OS back when they were installed on-premises but never got recertified for OS' with active security updates. And more than anywhere, granting secure remote access for 3rd party maintenance becomes essential.

Health case is also a perfect fit for a microsegmentation of the network to keep the impact of a potential leak as small as possible.

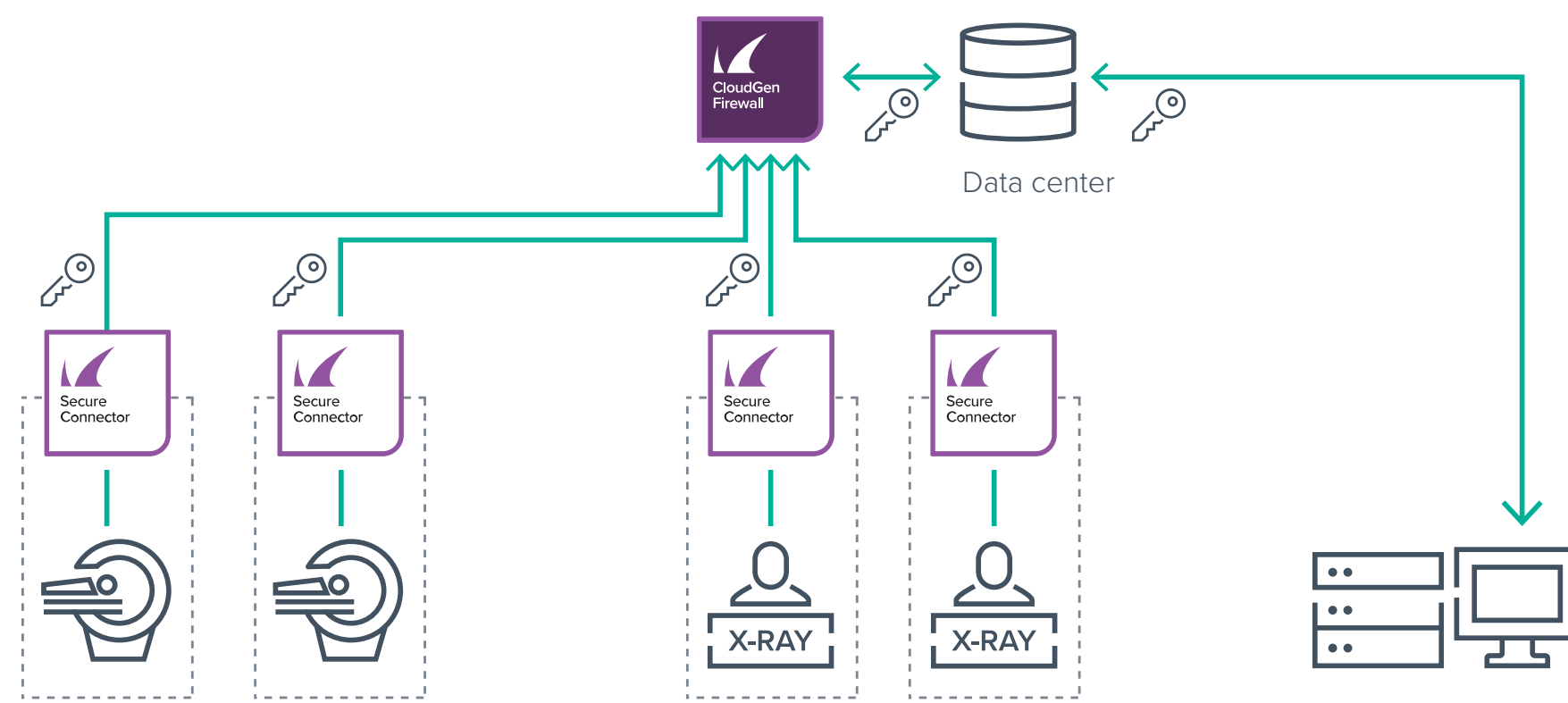

Figure 4 - IoT security in health care

IoT security in the public sector

The public sector is most likely the vertical with the highest number of variations of internet-connected devices. This can reach from smart meters, smart traffic signs, power lines, decentralized power generation, disposal logistics, pest control, etc. In this area the key to successful rollout of security is connectivity and manageability.

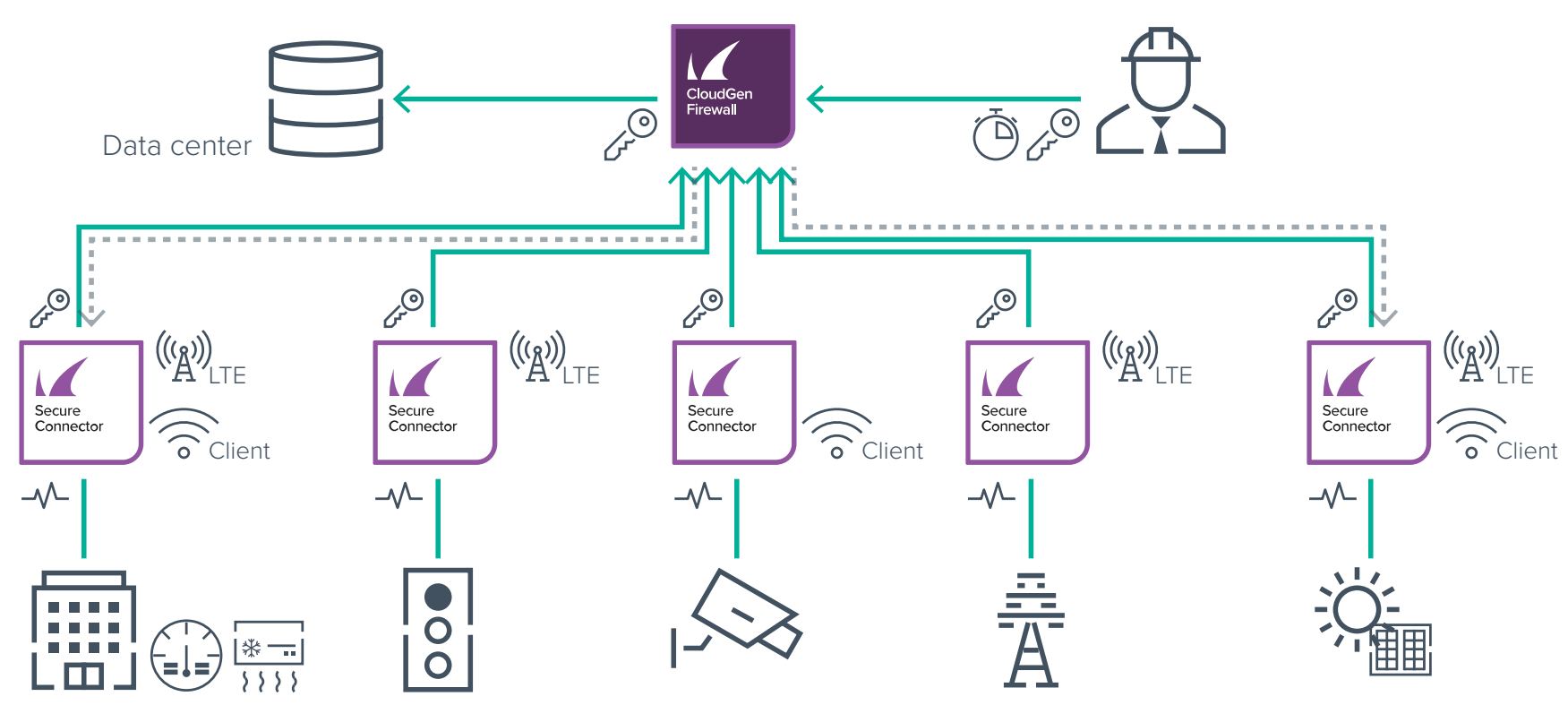

Figure 5 - IoT security in the public sector

IoT security in transportation

Whether pharmaceutical transports or waste disposal, you may want to know what is going on on your transport platforms. So it makes sense for transporting pharmaceuticals to know the storage temperature during delivery. Or the filling level of the garbage truck. In the area of public transport, the protection of information and advertising boards, video surveillance or WiFi hotspots fall within the area of infrastructure worth protecting.

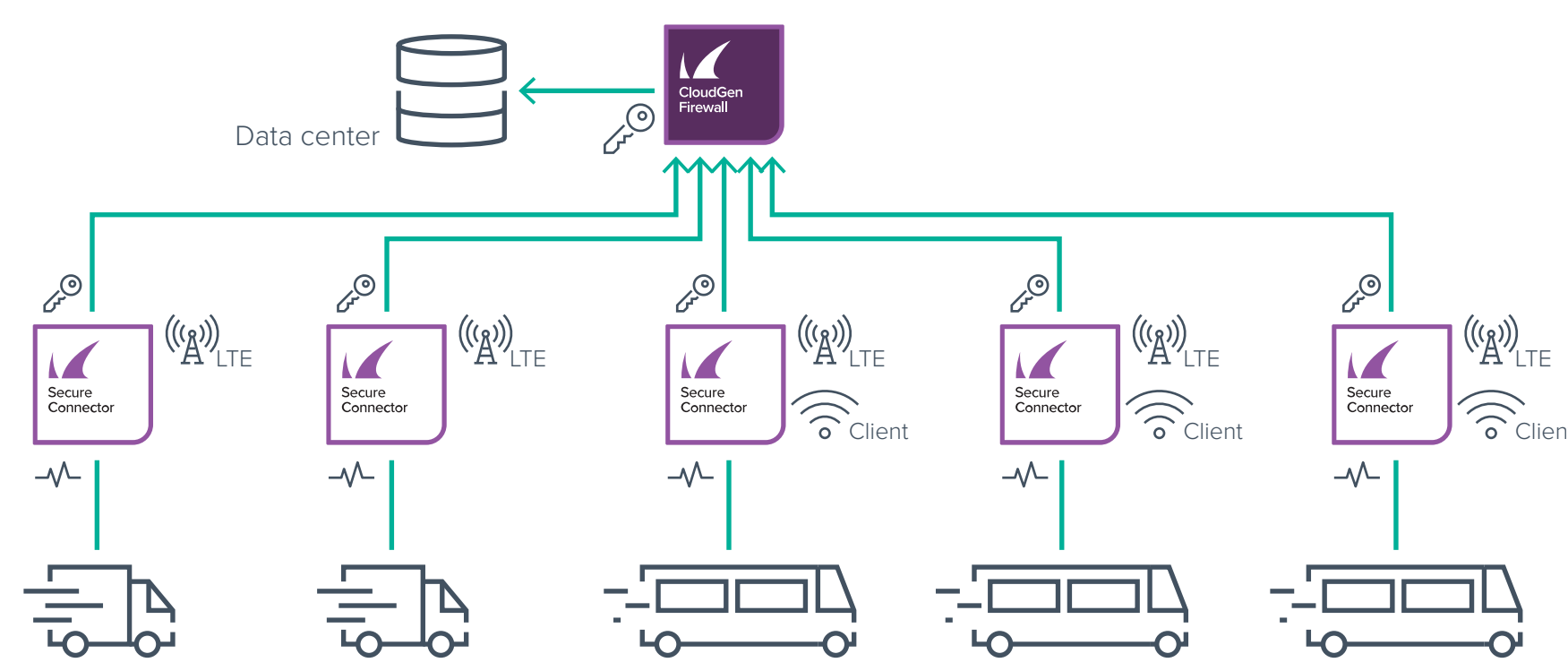

Figure 6 - IoT security in transportation

IoT security in energy

The main aspect in the energy sector is connectivity as wind parks, large solar plants, and oil drilling stations are usually not in town center. Granting these sites secure access to the databases they have to send data to, is essential. At the same time, maintenance is crucial. And - just in case - use a satellite uplink if everything else is not available.

General use cases

Unique digital identity

If you need to manage hundreds or thousands of devices, it is crucial that you can identify every single unit. Deploying Secure Connector appliances and CloudGen Firewall units allows assigning a unique digital identity, based on digital certificates via VPN, for every connected device. Only an absolutely certain digital identity allows granular management of large IoT deployments.

Predictive maintenance

The challenge is to combine security, usability, economic efficiency, and scalability. Barracuda Secure Connector appliances provide a Linux container for third party maintenance organizations to run their own control and management applications and establish an encrypted connection to Barracuda CloudGen Firewall for access control, security scanning and policy enforcement. Compared to legacy systems with industrial PCs and regular dial-in via VPN, this is much more scalable, involves almost no manual labor and the information is available all the time from anywhere.

Hardware facts

Model comparison

Barracuda offers several different models of SC appliances. For easier navigation through the available SC models, please find an overview on the differences below:

MODEL COMPARISON	SC20	SC21	SC24	SC25	SC30	SC31	SC34	SC35
Detailed information available on	page 9	page 10	page 11	page 12	page 13	page 14	page 15	page 16
Availability	globally	globally	globally	globally	globally	globally	EMEA / APAC	EMEA / APAC
INTERFACES								
WAN copper NICs (PoE-recipient)	1x1 GbE	1x1 GbE	1x1 GbE	1x1 GbE	1x1 GbE	1x1 GbE	1x1 GbE	1x1 GbE
LAN copper NICs (Switch)	3x1 GbE	3x1 GbE	3x1 GbE	3x1 GbE	3x1 GbE	3x1 GbE	3x1 GbE	3x1 GbE
USB 2.0	1	1	1	1	1	1	1	1
Micro-USB OTG	1	1	1	1	-	-	-	-
WiFi (Access Point / Client Mode) ¹	-	✓	-	✓	-	✓	-	✓
3G / UMTS support ¹	-	-	✓	✓	-	-	✓	✓
4G / LTE support Europe ¹	-	-	✓	✓	-	-	✓	✓
THROUGHPUT								
Firewall (UDP) [Mbps]	300	300	300	300	300	300	300	300
WiFi AP mode (UDP) [Mbps]	N/A	80	N/A	80	N/A	80	N/A	80
SD-WAN (AES-128, SHA) [Mbps]	30	30	30	30	30	30	30	30
MEMORY								
RAM [GB]	1	1	1	1	2	2	2	2
MASS STORAGE								
Type	Micro SD	Micro SD	Micro SD	Micro SD	Micro SD	Micro SD	Micro SD	Micro SD
Size Micro SD [GB]	16	16	16	16	16	16	16	16
Size On-board [GB]	-	-	-	-	8	8	8	8
SIZE, WEIGHT, DIMENSIONS								
Weight appliance [lbs]	1.21	1.21	1.21	1.21	2.54	2.54	2.54	2.54
Weight appliance [kg]	0.55	0.55	0.55	0.55	1.15	1.15	1.15	1.15
Appliance size upright/ DIN rail (W x D x H) [in]	1.5 x 5.5 x 5.9	1.5 x 5.5 x 5.9	1.5 x 5.5 x 5.9	1.5 x 5.5 x 5.9	3.07 x 4.72 x 5.91	3.07 x 4.72 x 5.91	3.07 x 4.72 x 5.91	3.07 x 4.72 x 5.91
Appliance size upright/ DIN rail (W x D x H) [mm]	37 x 140 x 150	37 x 140 x 150	37 x 140 x 150	37 x 140 x 150	78 x 120 x 150	78 x 120 x 150	78 x 120 x 150	78 x 120 x 150
Form factor	Compact, DIN rail	Compact, DIN rail	Compact, DIN rail	Compact, DIN rail	Rugged, DIN rail	Rugged, DIN rail	Rugged, DIN rail	Rugged, DIN rail
HARDWARE								
Cooling	Fanless	Fanless	Fanless	Fanless	Fanless	Fanless	Fanless	Fanless

¹ For detailed information on supported frequencies, please refer to "Wi-Fi, 3G, and 4G specifications" on page 17.

Secure Connector FSC20

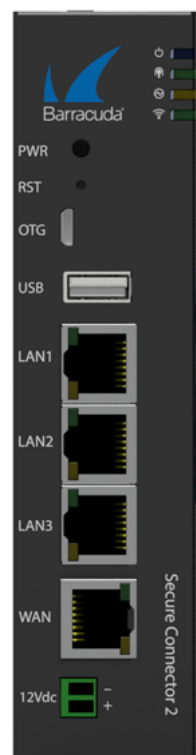

INTERFACES	
WAN copper ethernet NICs (PoE-recipient)	1x1 GbE
LAN copper NICs (LAN switch)	3x1 GbE
USB 2.0	1
Micro-USB OTG	1
WiFi (access point / client mode)	-
SUPPORTED CELLULAR NETWORKS	
GSM / UMTS	-
4G / LTE	-
PERFORMANCE [AS OF FIRMWARE RELEASE 8.3.X]	
Firewall throughput (UDP) [Mbps]	300
WiFi AP mode throughput (UDP) [Mbps]	N/A
SD-WAN throughput (AES-128, SHA) [Mbps] ^[a]	30
MEMORY	
RAM [GB]	1
MASS STORAGE	
Type	Micro SD
Size [GB]	16
SIZE, WEIGHT, DIMENSIONS (ALSO SEE PAGE 31)	
Weight appliance [lbs] / [kg]	1.21 / 0.55
Appliance size: width x depth x height [in]	1.5 x 5.5 x 5.9
Appliance size: width x depth x height [mm]	37 x 140 x 150
Weight carton with appliance [lbs] / [kg]	1.98 / 0.9
Carton size: width x depth x height [in]	2.6 x 9.1 x 10.8
Carton size: width x depth x height [mm]	65 x 230 x 275
Form factor	Compact, DIN rail
HARDWARE	
Cooling	Fanless
ENVIRONMENTAL	
Noise emission [db/A]	N/A
Operating temperature [°F] / [°C]	+30 to +105 / 0 to +40
Storage temperature [°F] / [°C]	-5 to +160 / -20 to +70
Operating humidity (non-condensing)	5% to 95%

This appliance is PoE-recipient compatible and, thus, has no external power brick included. However, an external power brick can be ordered as an option.

MTBF [SYSTEM]	
MTBF [yrs.] ^[b]	> 5
DEFAULT POWER SUPPLY	
AuxDC in voltage range (2-pin terminal block MC420 3.5mm) [V]	12 - 57
WAN Port PoE Voltage range [V]	37 - 54
Compatible PoE provider (PSE)	IEEE 802.3at (Type 2) PD
OPTIONAL POWER SUPPLY AND EFFICIENCY	
Power supply type	Single, ext. power brick
Power type [AC/DC]	AC
Input rating [Volts]	100-240
Input frequency [Hz]	50-60
Max. power draw [W]	40
Max. power draw @ 12V [Amps.]	3.33
Max. heat dissipation [W]	40
Max. heat dissipation [BTU]	205
Energy efficiency [average]	> 83%
Operating temperature [°F] / [°C]	+32 to +104 / 0 to +40
CERTIFICATIONS & COMPLIANCE (ALSO SEE PAGE 30 FF)	
CE emissions	✓
CE electrical safety	✓
FCC emissions	✓
ROHS compliant	✓
PACKAGING CONTENT	
Appliance	✓
Straight network cable	✓
USB type A to MicroUSB cable	✓
External power brick & cables	Optional
Quick start guide	✓
1x DIN rail bracket	✓
1x 2-pin power connector	✓
2x WiFi antenna	-
2x Cellular antenna with 1.5m cable	-

All performance values are measured under optimized conditions and are to be considered as „up to“ values and may vary depending on system configuration and infrastructure:

- a SD-WAN throughput is based on 1415 Byte UDP packets, bidirectional using BreakingPoint traffic generator.
- b MTBF according to common usage. High load on SSD and extreme environmental conditions might reduce MTBF.

Errors and omissions excepted. Specifications subject to change without notice.

Secure Connector FSC21

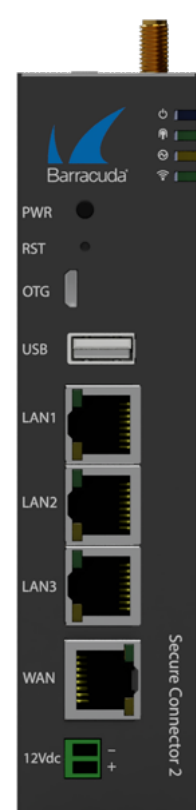

INTERFACES	
WAN copper ethernet NICs (PoE-recipient)	1x1 GbE
LAN copper NICs (LAN switch)	3x1 GbE
USB 2.0	1
Micro-USB OTG	1
WiFi (access point / client mode)	✓
SUPPORTED CELLULAR NETWORKS	
GSM / UMTS	-
4G / LTE	-
PERFORMANCE [AS OF FIRMWARE RELEASE 8.3.X]	
Firewall throughput (UDP) [Mbps]	300
WiFi AP mode throughput (UDP) [Mbps]	80
SD-WAN throughput (AES-128, SHA) [Mbps] ^[a]	30
MEMORY	
RAM [GB]	1
MASS STORAGE	
Type	Micro SD
Size [GB]	16
SIZE, WEIGHT, DIMENSIONS (ALSO SEE PAGE 32)	
Weight appliance [lbs] / [kg]	1.21 / 0.55
Appliance size: width x depth x height [in]	1.5 x 5.5 x 5.9
Appliance size: width x depth x height [mm]	37 x 140 x 150
Weight carton with appliance [lbs] / [kg]	1.98 / 0.9
Carton size: width x depth x height [in]	2.6 x 9.1 x 10.8
Carton size: width x depth x height [mm]	65 x 230 x 275
Form factor	Compact, DIN rail
HARDWARE	
Cooling	Fanless
ENVIRONMENTAL	
Noise emission [db/A]	N/A
Operating temperature [°F] / [°C]	+30 to +105 / 0 to +40
Storage temperature [°F] / [°C]	-5 to +160 / -20 to +70
Operating humidity (non-condensing)	5% to 95%

This appliance is PoE-recipient compatible and, thus, has no external power brick included. However, an external power brick can be ordered as an option.

MTBF [SYSTEM]	
MTBF [yrs.] ^[b]	> 5
DEFAULT POWER SUPPLY	
AuxDC in voltage range (2-pin terminal block MC420 3.5mm) [V]	12 - 57
WAN Port PoE Voltage range [V]	37 - 54
Compatible PoE provider (PSE)	IEEE 802.3at (Type 2) PD
OPTIONAL POWER SUPPLY AND EFFICIENCY	
Power supply type	Single, ext. power brick
Power type [AC/DC]	AC
Input rating [Volts]	100-240
Input frequency [Hz]	50-60
Max. power draw [W]	40
Max. power draw @ 12V [Amps.]	3.33
Max. heat dissipation [W]	40
Max. heat dissipation [BTU]	205
Energy efficiency [average]	> 83%
Operating temperature [°F] / [°C]	+32 to +104 / 0 to +40
CERTIFICATIONS & COMPLIANCE (ALSO SEE PAGE 30 FF)	
CE emissions	✓
CE electrical safety	✓
FCC emissions	✓
ROHS compliant	✓
PACKAGING CONTENT	
Appliance	✓
Straight network cable	✓
USB type A to MicroUSB cable	✓
External power brick & cables	Optional
Quick start guide	✓
1x DIN rail bracket	✓
1x 2-pin power connector	✓
2x WiFi antenna	✓
2x Cellular antenna with 1.5m cable	-

All performance values are measured under optimized conditions and are to be considered as „up to“ values and may vary depending on system configuration and infrastructure:

- a SD-WAN throughput is based on 1415 Byte UDP packets, bidirectional using BreakingPoint traffic generator.
- b MTBF according to common usage. High load on SSD and extreme environmental conditions might reduce MTBF.

Errors and omissions excepted. Specifications subject to change without notice.

Secure Connector FSC24B



INTERFACES	
WAN copper ethernet NICs (PoE-recipient)	1x1 GbE
LAN copper NICs (LAN switch)	3x1 GbE
USB 2.0	1
Micro-USB OTG	1
WiFi (access point / client mode)	-
SUPPORTED CELLULAR NETWORKS	
GSM / UMTS	✓
4G / LTE	✓
PERFORMANCE [AS OF FIRMWARE RELEASE 8.3.X]	
Firewall throughput (UDP) [Mbps]	300
WiFi AP mode throughput (UDP) [Mbps]	N/A
SD-WAN throughput (AES-128, SHA) [Mbps] ^[a]	30
MEMORY	
RAM [GB]	1
MASS STORAGE	
Type	Micro SD
Size [GB]	16
SIZE, WEIGHT, DIMENSIONS (ALSO SEE PAGE 33)	
Weight appliance [lbs] / [kg]	1.21 / 0.55
Appliance size: width x depth x height [in]	1.5 x 5.5 x 5.9
Appliance size: width x depth x height [mm]	37 x 140 x 150
Weight carton with appliance [lbs] / [kg]	1.98 / 0.9
Carton size: width x depth x height [in]	2.6 x 9.1 x 10.8
Carton size: width x depth x height [mm]	65 x 230 x 275
Form factor	Compact, DIN rail
HARDWARE	
Cooling	Fanless
ENVIRONMENTAL	
Noise emission [db/A]	N/A
Operating temperature [°F] / [°C]	+30 to +105 / 0 to +40
Storage temperature [°F] / [°C]	-5 to +160 / -20 to +70
Operating humidity (non-condensing)	5% to 95%

This appliance is PoE-recipient compatible and, thus, has no external power brick included. However, an external power brick can be ordered as an option.

MTBF [SYSTEM]	
MTBF [yrs.] ^[b]	> 5
DEFAULT POWER SUPPLY	
AuxDC in voltage range (2-pin terminal block MC420 3.5mm) [V]	12 - 57
WAN Port PoE Voltage range [V]	37 - 54
Compatible PoE provider (PSE)	IEEE 802.3at (Type 2) PD
OPTIONAL POWER SUPPLY AND EFFICIENCY	
Power supply type	Single, ext. power brick
Power type [AC/DC]	AC
Input rating [Volts]	100-240
Input frequency [Hz]	50-60
Max. power draw [W]	40
Max. power draw @ 12V [Amps.]	3.33
Max. heat dissipation [W]	40
Max. heat dissipation [BTU]	205
Energy efficiency [average]	> 83%
Operating temperature [°F] / [°C]	+32 to +104 / 0 to +40
CERTIFICATIONS & COMPLIANCE (ALSO SEE PAGE 30 FF)	
CE emissions	✓
CE electrical safety	✓
FCC emissions	✓
ROHS compliant	✓
PACKAGING CONTENT	
Appliance	✓
Straight network cable	✓
USB type A to MicroUSB cable	✓
External power brick & cables	Optional
Quick start guide	✓
1x DIN rail bracket	✓
1x 2-pin power connector	✓
2x WiFi antenna	-
2x Cellular antenna with 1.5m cable	✓

All performance values are measured under optimized conditions and are to be considered as „up to“ values and may vary depending on system configuration and infrastructure:

- a SD-WAN throughput is based on 1415 Byte UDP packets, bidirectional using BreakingPoint traffic generator.
- b MTBF according to common usage. High load on SSD and extreme environmental conditions might reduce MTBF.

Errors and omissions excepted. Specifications subject to change without notice.

Secure Connector FSC25B

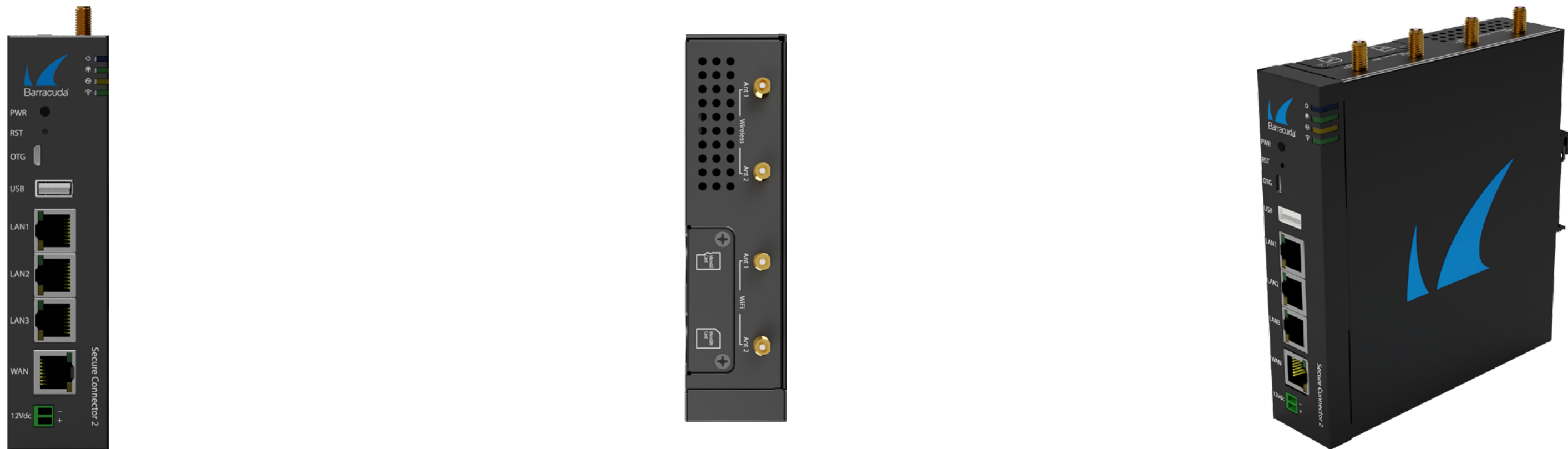

INTERFACES	
WAN copper ethernet NICs (PoE-recipient)	1x1 GbE
LAN copper NICs (LAN switch)	3x1 GbE
USB 2.0	1
Micro-USB OTG	1
WiFi (access point / client mode)	✓
SUPPORTED CELLULAR NETWORKS	
GSM / UMTS	✓
4G / LTE	✓
PERFORMANCE [AS OF FIRMWARE RELEASE 8.3.X]	
Firewall throughput (UDP) [Mbps]	300
WiFi AP mode throughput (UDP) [Mbps]	80
SD-WAN throughput (AES-128, SHA) [Mbps] ^[a]	30
MEMORY	
RAM [GB]	1
MASS STORAGE	
Type	Micro SD
Size [GB]	16
SIZE, WEIGHT, DIMENSIONS (ALSO SEE PAGE 34)	
Weight appliance [lbs] / [kg]	1.21 / 0.55
Appliance size: width x depth x height [in]	1.5 x 5.5 x 5.9
Appliance size: width x depth x height [mm]	37 x 140 x 150
Weight carton with appliance [lbs] / [kg]	1.98 / 0.9
Carton size: width x depth x height [in]	2.6 x 9.1 x 10.8
Carton size: width x depth x height [mm]	65 x 230 x 275
Form factor	Compact, DIN rail
HARDWARE	
Cooling	Fanless
ENVIRONMENTAL	
Noise emission [db/A]	N/A
Operating temperature [°F] / [°C]	+30 to +105 / 0 to +40
Storage temperature [°F] / [°C]	-5 to +160 / -20 to +70
Operating humidity (non-condensing)	5% to 95%
MTBF [SYSTEM]	
MTBF [yrs.] ^[b]	> 5

DEFAULT POWER SUPPLY	
AuxDC in voltage range (2-pin terminal block MC420 3.5mm) [V]	12 - 57
WAN Port PoE Voltage range [V]	37 - 54
Compatible PoE provider (PSE)	IEEE 802.3at (Type 2) PD
OPTIONAL POWER SUPPLY AND EFFICIENCY	
Power supply type	Single, ext. power brick
Power type [AC/DC]	AC
Input rating [Volts]	100-240
Input frequency [Hz]	50-60
Max. power draw [W]	40
Max. power draw @ 12V [Amps.]	3.33
Max. heat dissipation [W]	40
Max. heat dissipation [BTU]	205
Energy efficiency [average]	> 83%
Operating temperature [°F] / [°C]	+32 to +104 / 0 to +40
CERTIFICATIONS & COMPLIANCE (ALSO SEE PAGE 30 FF)	
CE emissions	✓
CE electrical safety	✓
FCC emissions	✓
ROHS compliant	✓
PACKAGING CONTENT	
Appliance	✓
Straight network cable	✓
USB type A to MicroUSB cable	✓
External power brick & cables	Optional
Quick start guide	✓
1x DIN rail bracket	✓
1x 2-pin power connector	✓
2x WiFi antenna	✓
2x Cellular antenna with 1.5m cable	✓

All performance values are measured under optimized conditions and are to be considered as „up to“ values and may vary depending on system configuration and infrastructure:

- a SD-WAN throughput is based on 1415 Byte UDP packets, bidirectional using BreakingPoint traffic generator.
- b MTBF according to common usage. High load on SSD and extreme environmental conditions might reduce MTBF.

Errors and omissions excepted. Specifications subject to change without notice.

This appliance is PoE-recipient compatible and, thus, has no external power brick included. However, an external power brick can be ordered as an option.

Secure Connector FSC30

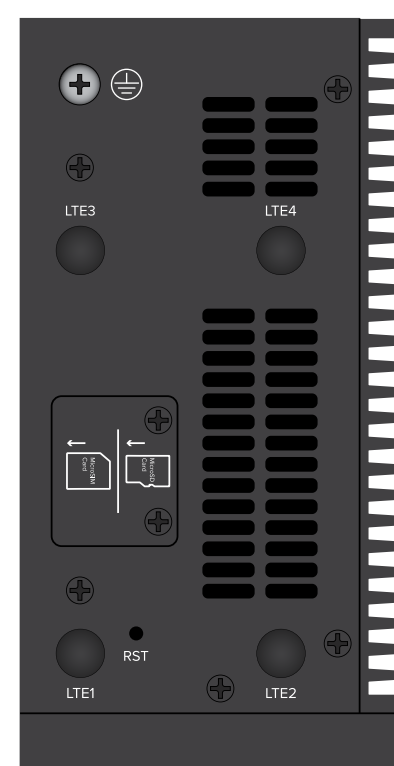
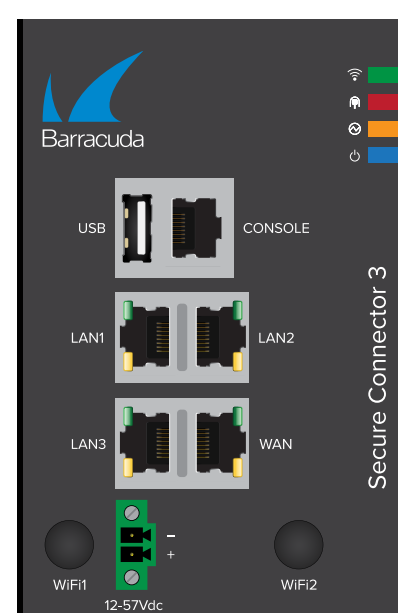

INTERFACES	
WAN copper ethernet NICs (PoE-recipient)	1x1 GbE
LAN copper NICs (LAN switch)	3x1 GbE
USB 2.0	1
Serial console	RJ45
WiFi (access point / client mode)	N/A
SUPPORTED CELLULAR NETWORKS	
4G / LTE	N/A
PERFORMANCE [AS OF FIRMWARE RELEASE 8.3.X]	
Firewall throughput (UDP) [Mbps]	300
WiFi AP mode throughput (UDP) [Mbps]	N/A
SD-WAN throughput (AES-128, SHA) [Mbps] ^[a]	30
MEMORY	
RAM [GB]	2
MASS STORAGE	
Size On-board [GB]	8
Size Micro SD [GB]	16
SIZE, WEIGHT, DIMENSIONS	
Weight appliance [lbs] / [kg]	2.54 / 1.15
Appliance size: width x depth x height [in]	3.07 x 4.72 x 5.91
Appliance size: width x depth x height [mm]	78 x 120 x 150
Weight carton with appliance [lbs] / [kg]	4.08 / 1.85
Carton size: width x depth x height [in]	7.48 x 8.94 x 7
Carton size: width x depth x height [mm]	190 x 227 x 178
Form factor	Rugged, DIN rail
HARDWARE	
Cooling	Fanless
ENVIRONMENTAL	
Noise emission [db/A]	N/A
Operating temperature [°F] / [°C]	-4 to +158 / -20 to +70
Storage temperature [°F] / [°C]	-4 to +158 / -20 to +70
Operating humidity (non-condensing)	5% to 95%

This appliance is PoE-recipient compatible and, thus, has no external power brick included. However, an external power brick can be ordered as an option.

MTBF [SYSTEM]	
MTBF [yrs.] ^[b]	> 5
DEFAULT POWER SUPPLY	
AuxDC in voltage range (2-pin terminal block MC420 3.5mm) [V]	12 - 57
WAN Port PoE Voltage range [V]	37 - 54
Compatible PoE provider (PSE)	IEEE 802.3at (Type 2) PD
OPTIONAL POWER SUPPLY AND EFFICIENCY	
Power supply type	Single, ext. power brick
Power type [AC/DC]	DC
Input rating [Volts]	12-36
Max. power draw [W]	60
Max. power draw @ 12V [Amps.]	2.5
Max. heat dissipation [W]	60
Max. heat dissipation [BTU]	205
Energy efficiency [average]	> 83%
Operating temperature [°F] / [°C]	+32 to +104 / 0 to +40
CERTIFICATIONS & COMPLIANCE (ALSO SEE PAGE 30 FF)	
CE emissions	✓
CE electrical safety	✓
FCC emissions	✓
ROHS compliant	✓
Shock and vibration resistance	IEC 60068 IEC 60950 IEC 61000 ISTA 2A
Protection classification	IP20 standard
PACKAGING CONTENT	
Appliance	✓
Straight network cable	✓
External power brick & cables	Optional
Quick start guide	✓
1x DIN rail bracket	✓
1x 2-pin power connector	✓

All performance values are measured under optimized conditions and are to be considered as „up to“ values and may vary depending on system configuration and infrastructure:

- a SD-WAN throughput is based on 1415 Byte UDP packets, bidirectional using BreakingPoint traffic generator.
- b MTBF according to common usage. High load on SSD and extreme environmental conditions might reduce MTBF.

Errors and omissions excepted. Specifications subject to change without notice.

Secure Connector FSC31

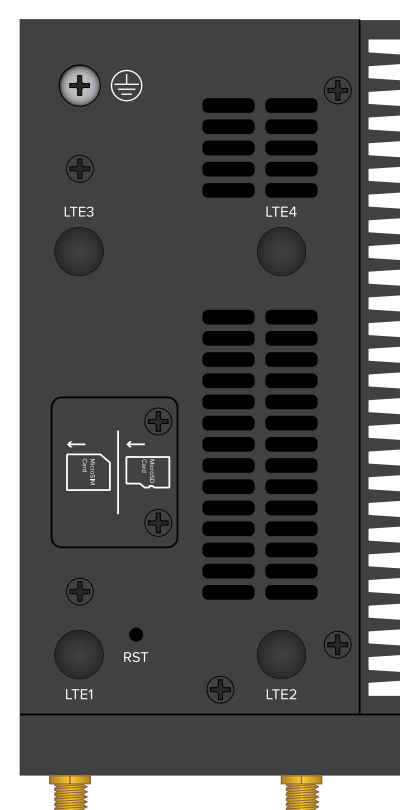
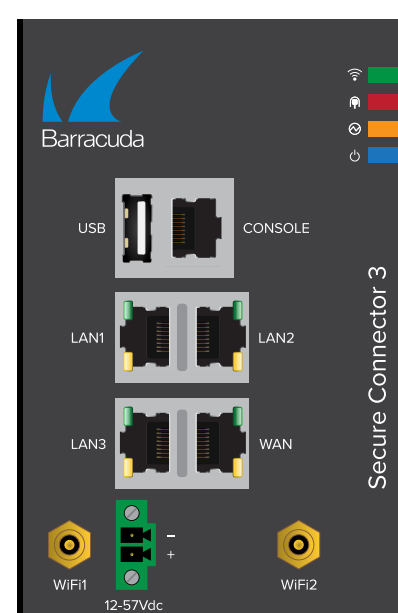

INTERFACES	
WAN copper ethernet NICs (PoE-recipient)	1x1 GbE
LAN copper NICs (LAN switch)	3x1 GbE
USB 2.0	1
Serial console	RJ45
WiFi (access point / client mode)	✓
SUPPORTED CELLULAR NETWORKS	
4G / LTE	N/A
PERFORMANCE [AS OF FIRMWARE RELEASE 8.3.X]	
Firewall throughput (UDP) [Mbps]	300
WiFi AP mode throughput (UDP) [Mbps]	80
SD-WAN throughput (AES-128, SHA) [Mbps] ^[a]	30
MEMORY	
RAM [GB]	2
MASS STORAGE	
Size On-board [GB]	8
Size Micro SD [GB]	16
SIZE, WEIGHT, DIMENSIONS	
Weight appliance [lbs] / [kg]	2.54 / 1.15
Appliance size: width x depth x height [in]	3.07 x 4.72 x 5.91
Appliance size: width x depth x height [mm]	78 x 120 x 150
Weight carton with appliance [lbs] / [kg]	4.08 / 1.85
Carton size: width x depth x height [in]	7.48 x 8.94 x 7
Carton size: width x depth x height [mm]	190 x 227 x 178
Form factor	Rugged, DIN rail
HARDWARE	
Cooling	Fanless
ENVIRONMENTAL	
Noise emission [db/A]	N/A
Operating temperature [°F] / [°C]	-4 to +158 / -20 to +70
Storage temperature [°F] / [°C]	-4 to +158 / -20 to +70
Operating humidity (non-condensing)	5% to 95%

This appliance is PoE-recipient compatible and, thus, has no external power brick included. However, an external power brick can be ordered as an option.

MTBF [SYSTEM]	
MTBF [yrs.] ^[b]	> 5
DEFAULT POWER SUPPLY	
AuxDC in voltage range (2-pin terminal block MC420 3.5mm) [V]	12 - 57
WAN Port PoE Voltage range [V]	37 - 54
Compatible PoE provider (PSE)	IEEE 802.3at (Type 2) PD
OPTIONAL POWER SUPPLY AND EFFICIENCY	
Power supply type	Single, ext. power brick
Power type [AC/DC]	DC
Input rating [Volts]	12-36
Max. power draw [W]	60
Max. power draw @ 12V [Amps.]	2.5
Max. heat dissipation [W]	60
Max. heat dissipation [BTU]	205
Energy efficiency [average]	> 83%
Operating temperature [°F] / [°C]	+32 to +104 / 0 to +40
CERTIFICATIONS & COMPLIANCE (ALSO SEE PAGE 30 FF)	
CE emissions	✓
CE electrical safety	✓
FCC emissions	✓
ROHS compliant	✓
Shock and vibration resistance	IEC 60068 IEC 60950 IEC 61000 ISTA 2A
Protection classification	IP20 standard
PACKAGING CONTENT	
Appliance	✓
Straight network cable	✓
External power brick & cables	Optional
Quick start guide	✓
1x DIN rail bracket	✓
1x 2-pin power connector	✓
2x WiFi antenna	✓
4x Cellular antenna with 1.5m cable	✓

All performance values are measured under optimized conditions and are to be considered as „up to“ values and may vary depending on system configuration and infrastructure:

- a SD-WAN throughput is based on 1415 Byte UDP packets, bidirectional using BreakingPoint traffic generator.
- b MTBF according to common usage. High load on SSD and extreme environmental conditions might reduce MTBF.

Errors and omissions excepted. Specifications subject to change without notice.

Secure Connector FSC34

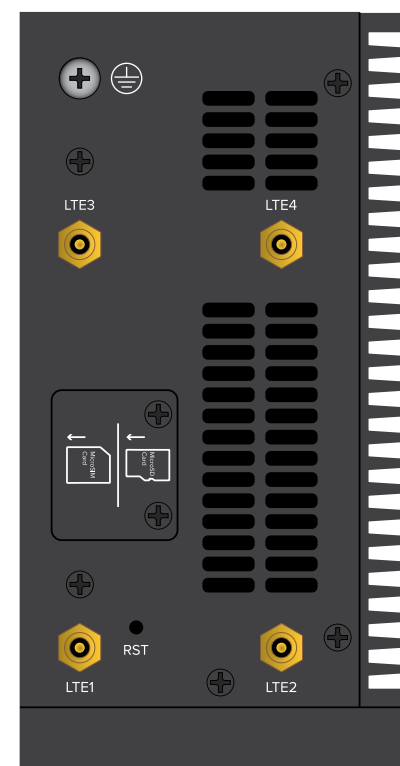
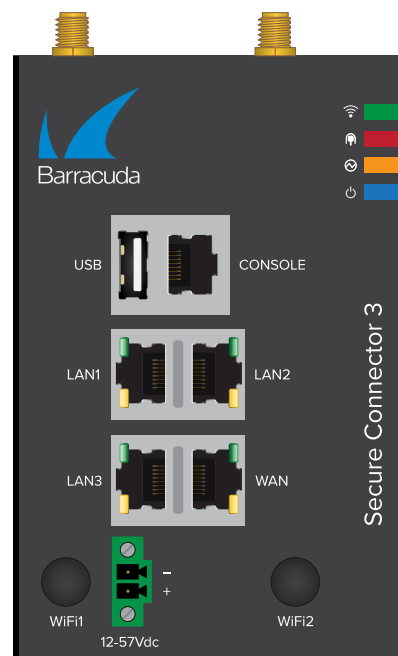

INTERFACES	
WAN copper ethernet NICs (PoE-recipient)	1x1 GbE
LAN copper NICs (LAN switch)	3x1 GbE
USB 2.0	1
Serial console	RJ45
WiFi (access point / client mode)	N/A
SUPPORTED CELLULAR NETWORKS	
4G / LTE	✓
PERFORMANCE [AS OF FIRMWARE RELEASE 8.3.X]	
Firewall throughput (UDP) [Mbps]	300
WiFi AP mode throughput (UDP) [Mbps]	N/A
SD-WAN throughput (AES-128, SHA) [Mbps] ^[a]	30
MEMORY	
RAM [GB]	2
MASS STORAGE	
Size On-board [GB]	8
Size Micro SD [GB]	16
SIZE, WEIGHT, DIMENSIONS	
Weight appliance [lbs] / [kg]	2.54 / 1.15
Appliance size: width x depth x height [in]	3.07 x 4.72 x 5.91
Appliance size: width x depth x height [mm]	78 x 120 x 150
Weight carton with appliance [lbs] / [kg]	4.08 / 1.85
Carton size: width x depth x height [in]	7.48 x 8.94 x 7
Carton size: width x depth x height [mm]	190 x 227 x 178
Form factor	Rugged, DIN rail
HARDWARE	
Cooling	Fanless
ENVIRONMENTAL	
Noise emission [db/A]	N/A
Operating temperature [°F] / [°C]	-4 to +158 / -20 to +70
Storage temperature [°F] / [°C]	-4 to +158 / -20 to +70
Operating humidity (non-condensing)	5% to 95%

MTBF [SYSTEM]	
MTBF [yrs.] ^[b]	> 5
DEFAULT POWER SUPPLY	
AuxDC in voltage range (2-pin terminal block MC420 3.5mm) [V]	12 - 57
WAN Port PoE Voltage range [V]	37 - 54
Compatible PoE provider (PSE)	IEEE 802.3at (Type 2) PD
OPTIONAL POWER SUPPLY AND EFFICIENCY	
Power supply type	Single, ext. power brick
Power type [AC/DC]	DC
Input rating [Volts]	12-36
Max. power draw [W]	60
Max. power draw @ 12V [Amps.]	2.5
Max. heat dissipation [W]	60
Max. heat dissipation [BTU]	205
Energy efficiency [average]	> 83%
Operating temperature [°F] / [°C]	+32 to +104 / 0 to +40
CERTIFICATIONS & COMPLIANCE (ALSO SEE PAGE 30 FF)	
CE emissions	✓
CE electrical safety	✓
FCC emissions	✓
ROHS compliant	✓
Shock and vibration resistance	IEC 60068 IEC 60950 IEC 61000 ISTA 2A
Protection classification	IP20 standard
PACKAGING CONTENT	
Appliance	✓
Straight network cable	✓
External power brick & cables	Optional
Quick start guide	✓
1x DIN rail bracket	✓
1x 2-pin power connector	✓
4x Cellular antenna with 1.5m cable	✓

All performance values are measured under optimized conditions and are to be considered as „up to“ values and may vary depending on system configuration and infrastructure:

- a SD-WAN throughput is based on 1415 Byte UDP packets, bidirectional using BreakingPoint traffic generator.
- b MTBF according to common usage. High load on SSD and extreme environmental conditions might reduce MTBF.

Errors and omissions excepted. Specifications subject to change without notice.

This appliance is PoE-recipient compatible and, thus, has no external power brick included. However, an external power brick can be ordered as an option.

Secure Connector FSC35

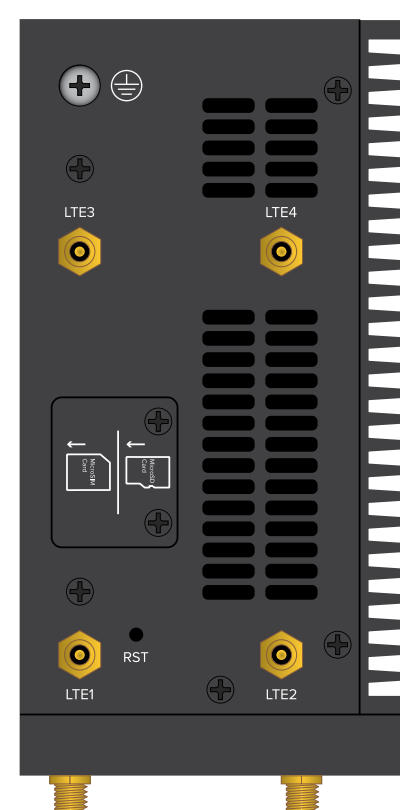
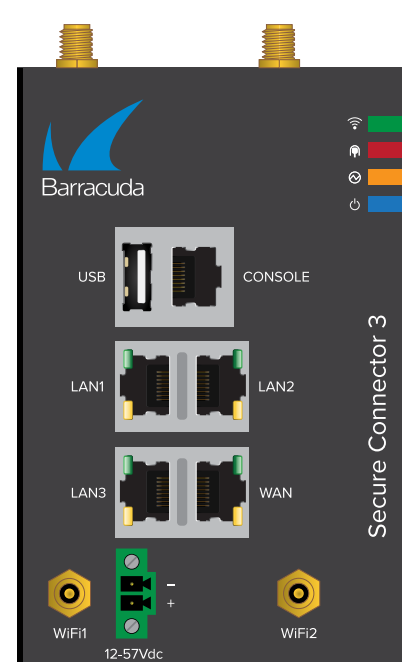

INTERFACES	
WAN copper ethernet NICs (PoE-recipient)	1x1 GbE
LAN copper NICs (LAN switch)	3x1 GbE
USB 2.0	1
Serial console	RJ45
WiFi (access point / client mode)	✓
SUPPORTED CELLULAR NETWORKS	
4G / LTE	✓
PERFORMANCE [AS OF FIRMWARE RELEASE 8.3.X]	
Firewall throughput (UDP) [Mbps]	300
WiFi AP mode throughput (UDP) [Mbps]	80
SD-WAN throughput (AES-128, SHA) [Mbps] ^[a]	30
MEMORY	
RAM [GB]	2
MASS STORAGE	
Size On-board [GB]	8
Size Micro SD [GB]	16
SIZE, WEIGHT, DIMENSIONS	
Weight appliance [lbs] / [kg]	2.54 / 1.15
Appliance size: width x depth x height [in]	3.07 x 4.72 x 5.91
Appliance size: width x depth x height [mm]	78 x 120 x 150
Weight carton with appliance [lbs] / [kg]	4.08 / 1.85
Carton size: width x depth x height [in]	7.48 x 8.94 x 7
Carton size: width x depth x height [mm]	190 x 227 x 178
Form factor	Rugged, DIN rail
HARDWARE	
Cooling	Fanless
ENVIRONMENTAL	
Noise emission [db/A]	N/A
Operating temperature [°F] / [°C]	-4 to +158 / -20 to +70
Storage temperature [°F] / [°C]	-4 to +158 / -20 to +70
Operating humidity (non-condensing)	5% to 95%

This appliance is PoE-recipient compatible and, thus, has no external power brick included. However, an external power brick can be ordered as an option.

MTBF [SYSTEM]	
MTBF [yrs.] ^[b]	> 5
DEFAULT POWER SUPPLY	
AuxDC in voltage range (2-pin terminal block MC420 3.5mm) [V]	12 - 57
WAN Port PoE Voltage range [V]	37 - 54
Compatible PoE provider (PSE)	IEEE 802.3at (Type 2) PD
OPTIONAL POWER SUPPLY AND EFFICIENCY	
Power supply type	Single, ext. power brick
Power type [AC/DC]	DC
Input rating [Volts]	12-36
Max. power draw [W]	60
Max. power draw @ 12V [Amps.]	2.5
Max. heat dissipation [W]	60
Max. heat dissipation [BTU]	205
Energy efficiency [average]	> 83%
Operating temperature [°F] / [°C]	+32 to +104 / 0 to +40
CERTIFICATIONS & COMPLIANCE (ALSO SEE PAGE 30 FF)	
CE emissions	✓
CE electrical safety	✓
FCC emissions	✓
ROHS compliant	✓
Shock and vibration resistance	IEC 60068 IEC 60950 IEC 61000 ISTA 2A
Protection classification	IP20 standard
PACKAGING CONTENT	
Appliance	✓
Straight network cable	✓
External power brick & cables	Optional
Quick start guide	✓
1x DIN rail bracket	✓
1x 2-pin power connector	✓
2x WiFi antenna	✓
4x Cellular antenna with 1.5m cable	✓

All performance values are measured under optimized conditions and are to be considered as „up to“ values and may vary depending on system configuration and infrastructure:

- a SD-WAN throughput is based on 1415 Byte UDP packets, bidirectional using BreakingPoint traffic generator.
- b MTBF according to common usage. High load on SSD and extreme environmental conditions might reduce MTBF.

Errors and omissions excepted. Specifications subject to change without notice.

Wi-Fi, 3G, and 4G specifications

Barracuda Networks cannot guarantee signal reception. In case your deployment is located in a basement or in a place with insufficient signal reception make sure that the signal quality is sufficient, especially prior to purchasing large quantities. The SIM card is not included and has to be obtained independently through a mobile phone provider.

WI-FI (AP OR CLIENT MODE)	FSC21	FSC25B	FSC31	FSC35
Integrated Wi-Fi (IEEE 802.11b/g)	2.4 GHz (2412 - 2462 MHz)	2.4 GHz (2412 - 2462 MHz)	2.4 GHz (2412 - 2462 MHz)	2.4 GHz (2412 - 2462 MHz)

4G / LTE	FSC24B	FSC25B	FSC34	FSC35
Frequencies (MHz)	GSM 850/900/1800/1900 UMTS 850/900/1900/2100 LTE 800/850/900/1800/2100/2600		UMTS 850/1900 LTE 700/750/850/1700/1900	
EDGE/GSM/GPRS power class	Power Class 4 (33 dBm) for GSM/E-GSM bands Power Class 1 (30 dBm) for DCS/PCS bands Power Class E2 (27 dBm) for GSM/E-GSM bands Power Class E2 (26 dBm) for DCS/PCS bands		n/a	n/a
WCDMA/HSDPA/HSUPA power class	Power Class 3 (24 dBm) for UMTS/HSDPA/HSUPA mode		Power Class 3 (24 dBm) for UMTS/HSDPA/HSUPA	
HSUPA mode LTE power class	Power Class 3 (23 dBm) for LTE mode		Power Class 3 (23 dBm) for LTE mode	
Data rate	LTE cat.4 HSUPA cat.6 HSDPA cat.14 GPRS class12 EDGE class126		LTE cat.4 HSUPA cat.6 HSDPA cat.24	
Supported data transmission	HSUPA HSDPA 3G UMTS EDGE		HSUPA HSDPA 3G UMTS	
SIM interface	3VDC 6-pin		3VDC 6-pin	

Connectivity and central administration

A sustainable IoT security concept also requires - besides the actual appliances at the IoT devices - solutions for consolidating connectivity and security settings and a solution for administering the complete deployment from a central interface.

Barracuda's IoT security solution covers these requirements with Barracuda CloudGen Firewall and Barracuda Firewall Control Center.

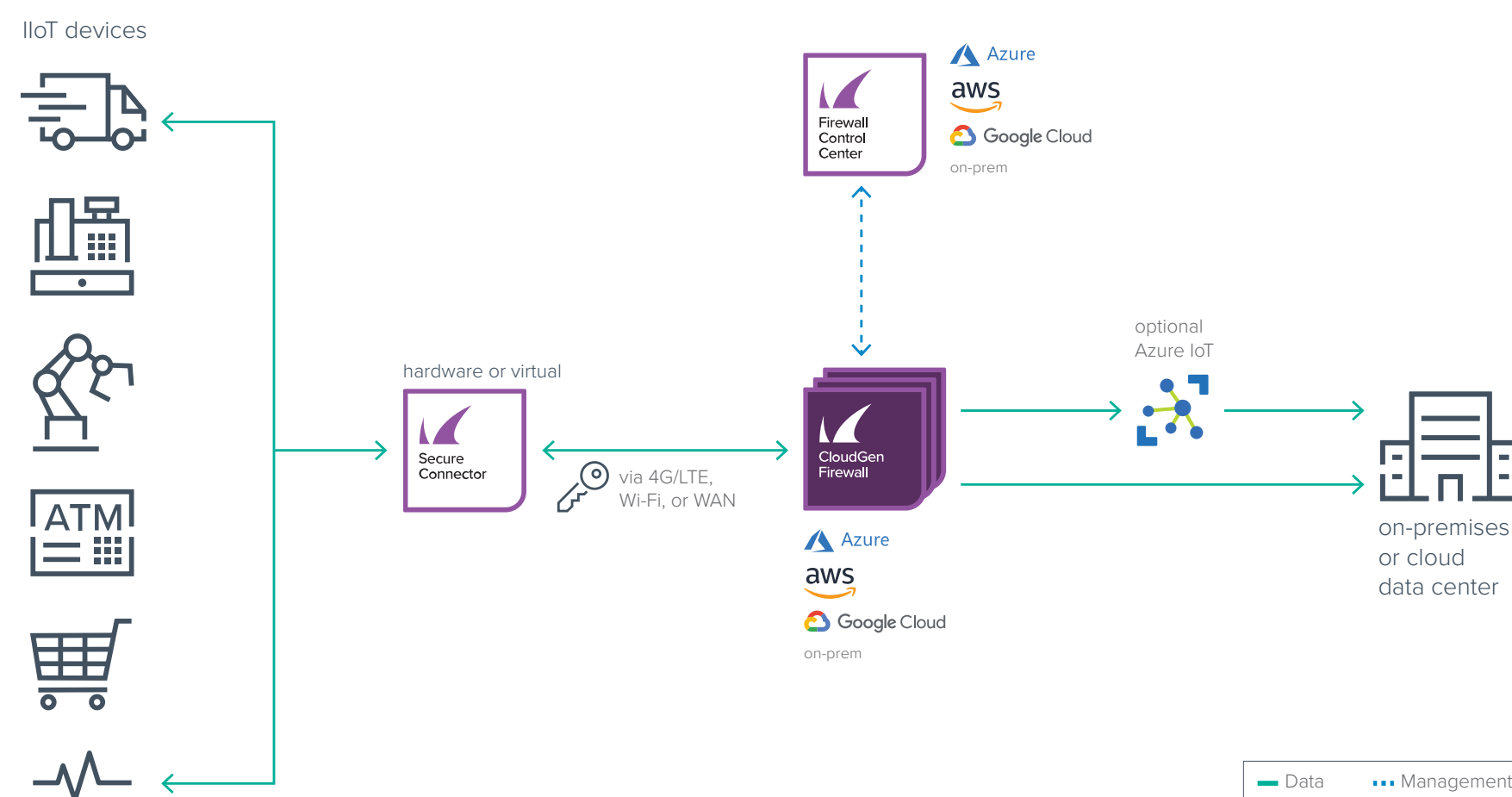

Figure 7 - Securing IIoT architecture

For more details on Barracuda Virtual Appliances, please visit barracuda.com/solutions/virtual.

Barracuda CloudGen Firewall

As shown in the illustration above, Barracuda CloudGen Firewall is the link pin between SC deployments directly at the IIoT devices and the data center where the data collected by the IIoT devices is to be processed.

CloudGen Firewall also applies full next-generation security features to the data flow.

Besides hardware models (for detailed hardware specifications, please see the [product overview for CloudGen Firewall](#)), CloudGen Firewall is available for:

PUBLIC CLOUDS	ON-PREM DISTRIBUTION
Azure AWS Google Cloud	VMware KVM Microsoft Hyper-V Citrix XenServer

Depending on the SC deployment size, Barracuda supports following number of SC's per CloudGen Firewall model:

MAX. NUMBER OF SC'S CONNECTED	10	20	40	60	85	100	175	400	500	750	1,250	2,000
CloudGen Firewall hardware model	F18 F80	n/a	F180 F93.R	F280 F93.R	F380	n/a	F400	F600	n/a	F800	F900	F1000
CloudGen Firewall virtual model	VF25	VF50	VF100	VF250	n/a	VF500	n/a	n/a	VF1000	VF2000	VF4000	VF8000

FOR DETAILED INFORMATION ON MANDATORY AND OPTIONAL SUBSCRIPTIONS, PLEASE SEE [PAGE 25](#)

Barracuda Firewall Control Center

To centralize management across many different firewalls and remote access users, the Barracuda Firewall Control Center enables administrators to manage and configure security, content, traffic management, and network access policies from a single interface. Template-based configuration and globally available security objects enable efficient configuration across thousands of locations.

The Firewall Control Center helps significantly reduce the cost associated with security management while providing extra functionality both centrally and locally at the managed gateway. Software patches and version upgrades are centrally controlled from within the management console and deployment can be applied to all managed devices.

Highly customizable administrative roles can be defined to delegate administrative capabilities for specific departments or locations.

Lifecycle management

Scalable CloudGen Firewall deployments offer companies sustainable investment protection. Energize Updates automatically provide the latest firmware and threat definitions to keep the appliance up-to-date. With a maintained Instant Replacement subscription, organizations receive a new appliance with the latest specs every four years.

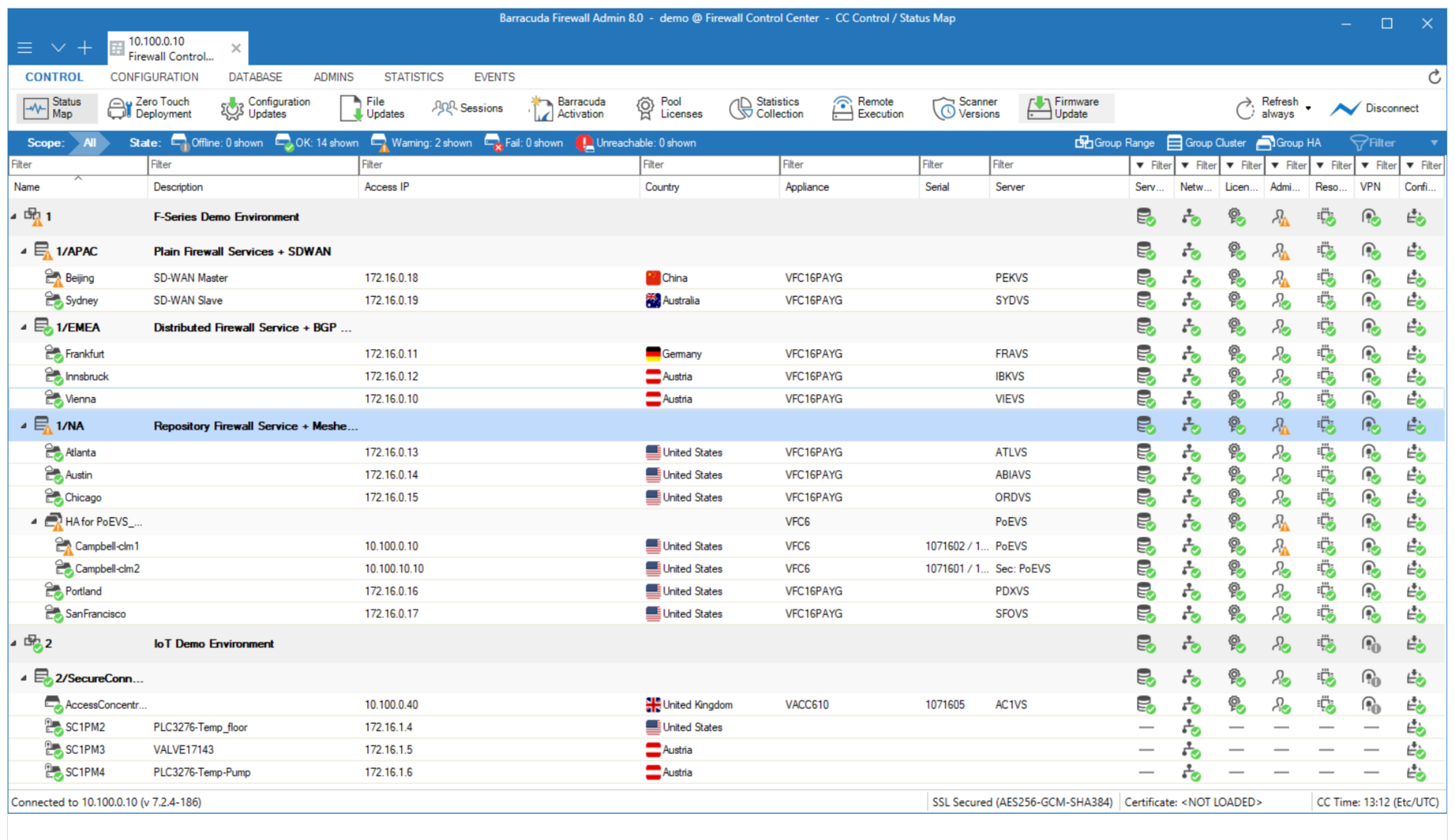

Figure 8 - Firewall Control Center's Status Map displays a drill down status overview of all centrally managed CloudGen Firewall deployments.

Scalable deployment

Managing the security issues in an IIoT network can be painful and extremely time consuming. Managing a single deployment with up to 2,000 SC may take only 30 minutes per day. With regular central management tools a single deployment can cross the 30-minutes limit very quickly and the larger the network the more hours will be required just to keep the network running.

With Barracuda Firewall Control Center, managing multiple deployments takes the same amount of time as managing one. [For more details, please click here.](#)

Cloud deployment

Moving infrastructure to the cloud does not stop at administration tools. Therefore, the Firewall Control Center is available for direct deployment in public cloud offerings like Microsoft Azure, Amazon Web Services, and Google Cloud Platform in a Bring-Your-Own-License model.

Zero-touch deployment

Especially for IoT-typical large rollouts without having IT personnel on the ground at remote locations, Firewall Control Center supports zero-touch deployment for all Barracuda components (i.e., Secure Connector and CloudGen Firewall). This feature allows to send Secure Connector hardware appliances to locations without having to pre-setup them beforehand.

After unpacking the appliance and powering it up, the appliance automatically connects to the zero-touch deployment service where it receives a very basic set of information. This information is just enough to create a high-secure TINA remote access connection to the private Firewall Control Center the appliance shall be assigned to.

The full configuration is sent to the appliance via the remote access tunnel and the Secure Connector becomes part of the security infrastructure without the need of dedicated and trained IT security administrators at the location.

Enterprise- and service provider licensing

The Firewall Control Center lets you centrally manage all licensing flexible and independently of hardware. This makes this type of licensing a perfect fit for large numbers of deployments across a wide geographic area.

Comparison of Barracuda Firewall Control Center models

FEATURES	VC400 VIRTUAL ENVIRONMENT	VCC400 PUBLIC CLOUD	VC610 VIRTUAL ENVIRONMENT	VCC610 PUBLIC CLOUD	VC820 VIRTUAL ENVIRONMENT
Max. no. of managed gateways [Recommended]	Unlimited [20]	Unlimited [20]	Unlimited [hardware-dependent]	Unlimited [hardware-dependent]	Unlimited [hardware-dependent]
Manageable configuration groupings	1	1	Unlimited	Unlimited	Unlimited
Multi-administrator support	✓	✓	✓	✓	✓
Role-based administration	✓	✓	✓	✓	✓
Revision control system	✓	✓	✓	✓	✓
Central statistics	✓	✓	✓	✓	✓
Central syslog host / relay	✓	✓	✓	✓	✓
Firewall audit information collector / viewer	✓	✓	✓	✓	✓
Barracuda access monitor	✓	✓	✓	✓	✓
High availability	Optional	Optional	Optional	Optional	HA license included
Multi-tenancy	-	-	Yes (via configuration grouping)		Yes (5 tenants)
Additional tenant for multi-tenancy	-	-	-	-	Optional

Supported SCADA protocols

Following, you find an overview on supported protocols that are used in industrial OT environments. For more detailed and most-recent information, please consult the [Application Explorer](#) hosted on [BarracudaCampus](#).

S7 sub-protocols

- S7 UserData - Mode Transition
- S7 Stop
- S7 Warm Restart
- S7 Run
- S7 UserData - Cyclic Data
- S7 Cyclic Data Unsubscribe
- S7 Cyclic Data Memory
- S7 Cyclic Data DB
- S7 UserData - Block Functions
- S7 List Blocks
- S7 List Blocks of Given Type
- S7 Get Block Info
- S7 UserData - CPU Functions
- S7 Read SZL
- S7 Notify Indication
- S7 Alarm-8 Indication
- S7 Alarm-8 Unlock
- S7 Alarm Ack
- S7 Alarm Ack Indication
- S7 Alarm Lock Indication
- S7 Alarm Query
- S7 Message Service
- S7 Notify-8 Indication
- S7 Diagnostic Message
- S7 Alarm-8 Lock
- S7 Scan Indication
- S7 Alarm Unlock Indication
- S7 Alarm-SQ Indication
- S7 Alarm-S Indication
- S7 UserData - Time Functions
- S7 Read Clock
- S7 Set Clock
- S7 UserData - Programmer Commands
- S7 Remove Diagnostic Data
- S7 Erase
- S7 Request Diagnostic Data
- S7 Variable Table
- S7 Read Diagnostic Data
- S7 Forces
- S7 UserData - Other Functions
- S7 PLC Password
- S7 PBC BSend/BRecv
- S7 Request/Response
- S7 PLC Stop
- S7 Write
- S7 Download
- S7 CPU Services
- S7 Upload
- S7 PLC Control
- S7 Setup Communication
- S7 Read
- S7 Other
- S7 Ack
- S7 Server Control
- S7 User Data
- S7 Comm (legacy)

S7+ sub-protocols

- S7+ Notification
- S7+ Notification (new version)
- S7+ Notification (old version)
- S7+ Other
- S7+ Extended Keep Alive
- S7+ Keep Alive
- S7+ Other / Not classified
- S7+ Request/Response
- S7+ Abort
- S7+ Add Link
- S7+ Begin Sequence
- S7+ Create Object
- S7+ Delete Object
- S7+ End Sequence
- S7+ Error
- S7+ Explore
- S7+ Get Link
- S7+ Get Multiple Variables
- S7+ Get Variable
- S7+ Get Variable Address
- S7+ Get Variable Substream
- S7+ Invoke
- S7+ Other
- S7+ Remove Link
- S7+ Set Multiple Variables
- S7+ Set Variable
- S7+ Set Variable Substream

IEC 60870-5-104 sub-protocols

- IEC 60870-5-104 Process Information in Monitoring Direction
- IEC 60870-5-104 Measured Value - Short Floating Point Number
- IEC 60870-5-104 Packed Single-Point Information with Status Change Detection
- IEC 60870-5-104 Measured Value - Normalized Value without Quality Descriptor
- IEC 60870-5-104 Single-Point Information with Time Tag
- IEC 60870-5-104 Measured Value - Short Floating Point Number with Time Tag
- IEC 60870-5-104 Packed Output Circuit Information of Protection Equipment with Time Tag
- IEC 60870-5-104 Double-Point Information
- IEC 60870-5-104 Step Position Information
- IEC 60870-5-104 Measured Value - Scaled
- IEC 60870-5-104 Integrated Totals
- IEC 60870-5-104 Double-Point Information with Time Tag
- IEC 60870-5-104 Step Position Information with Time Tag
- IEC 60870-5-104 Bitstring of 32 Bits with Time Tag
- IEC 60870-5-104 Event of Protection Equipment with Time Tag
- IEC 60870-5-104 Single-Point Information
- IEC 60870-5-104 Bitstring of 32 Bit
- IEC 60870-5-104 Measured Value - Normalized
- IEC 60870-5-104 Measured Value - Normalized Value with Time Tag
- IEC 60870-5-104 Measured Value - Scaled Value with Time Tag
- IEC 60870-5-104 Integrated Totals with Time Tag
- IEC 60870-5-104 Packed Start Events of Protection Equipment with Time Tag
- IEC 60870-5-104 System Information in Monitoring Direction
- IEC 60870-5-104 End of Initialization
- IEC 60870-5-104 System Information in Control Direction
- IEC 60870-5-104 Counter Interrogation Command
- IEC 60870-5-104 Read Command
- IEC 60870-5-104 Interrogation Command
- IEC 60870-5-104 Reset Process Command
- IEC 60870-5-104 Delay Acquisition Command
- IEC 60870-5-104 Test Command with Time Tag
- IEC 60870-5-104 File Transfer
- IEC 60870-5-104 File Ready
- IEC 60870-5-104 Section Ready
- IEC 60870-5-104 Directory
- IEC 60870-5-104 Call Directory, Select File, Call File, Call Section
- IEC 60870-5-104 ACK File - ACK Section
- IEC 60870-5-104 Segment
- IEC 60870-5-104 Query Log - Request Archive File
- IEC 60870-5-104 Process Information in Control Direction
- IEC 60870-5-104 Single Command
- IEC 60870-5-104 Set Point Command - Normalized Value
- IEC 60870-5-104 Set Point Command - Scaled Value
- IEC 60870-5-104 Set Point Command - Normalized Value with Time Tag
- IEC 60870-5-104 Regulating Step Command
- IEC 60870-5-104 Bitstring of 32 Bits
- IEC 60870-5-104 Single Command with Time Tag
- IEC 60870-5-104 Set Point Command - Short Floating - Point Number with Time Tag
- IEC 60870-5-104 Bitstring of 32 Bits with Time Tag
- IEC 60870-5-104 Double Command
- IEC 60870-5-104 Set Point Command - Short Floating Point Number
- IEC 60870-5-104 Double Command with Time Tag
- IEC 60870-5-104 Regulating Step Command with Time Tag
- IEC 60870-5-104 Set Point Command - Scaled Value with Time Tag
- IEC 60870-5-104 Parameter in Control Direction
- IEC 60870-5-104 Parameter of Measured Value - Normalized Value
- IEC 60870-5-104 Parameter of Measured Value - Scaled Value
- IEC 60870-5-104 Parameter of Measured Value - Short Floating Point Number
- IEC 60870-5-104 Parameter Activation

IEC 61850 sub-protocols

- IEC 61850 Goose
- IEC 61850 MMS
- IEC 61850 SMV
- IEC 61850 General

DNP3 sub-protocols

- DNP3 Control Functions
- DNP3 Operate
- DNP3 Select
- DNP3 Direct Operate
- DNP3 Direct Operate no ACK
- DNP3 Time Synchronization
- DNP3 Delay Measurement
- DNP3 Record Current Time
- DNP3 Transfer Functions
- DNP3 Read
- DNP3 Write
- DNP3 Confirm
- DNP3 Application Control
- DNP3 Cold Restart
- DNP3 Initialize Application
- DNP3 Start Application
- DNP3 Stop Application
- DNP3 Warm Restart
- DNP3 Initialize Data
- DNP3 Configuration
- DNP3 Save Configuration
- DNP3 Enable Spontaneous Messages
- DNP3 Assign Class
- DNP3 Disable Spontaneous Messages
- DNP3 Activate Configuration
- DNP3 Response Messages
- DNP3 Unsolicited Response
- DNP3 Authentication Response
- DNP3 Response
- DNP3 Other
- DNP3 Authentication Request
- DNP3 Authentication Error
- DNP3 Freeze Functions
- DNP3 Freeze and Clear
- DNP3 Freeze with Time
- DNP3 Immediate Freeze
- DNP3 Freeze and Clear no ACK
- DNP3 Immediate Freeze no ACK
- DNP3 Freeze with Time no ACK
- DNP3 File Access
- DNP3 Open File
- DNP3 Delete File
- DNP3 Abort File
- DNP3 Authenticate File
- DNP3 Close File
- DNP3 Get File Info

MODBUS sub-protocols

- MODBUS Data Access
- MODBUS Read Coils
- MODBUS Read Discrete Inputs
- MODBUS Read Holding Registers
- MODBUS Write Single Register
- MODBUS Read/Write Multiple Registers
- MODBUS Write Single Coil
- MODBUS Write Multiple Coils
- MODBUS Write Multiple Registers
- MODBUS Mask Write Register
- MODBUS Read FIFO Queue
- MODBUS Read Input Register
- MODBUS File Access
- MODBUS Read File Record
- MODBUS Write File Record
- MODBUS Diagnostics
- MODBUS Read Exception Status
- MODBUS Get Communication Event Log
- MODBUS Report Server ID
- MODBUS Diagnostic Check
- MODBUS Get Communication Event Counter
- MODBUS Encapsulated Interface Transport
- MODBUS Read Device Identification
- MODBUS CAN-Open General Reference
- MODBUS (legacy)

Available subscriptions

Availability matrix

	SC	CLOUDGEN FIREWALL
AVAILABLE SOFTWARE/FEATURE SUBSCRIPTIONS		
Energize Updates (EU)	Mandatory	Mandatory
Malware Protection	-	Optional
Advanced Threat Protection	-	Optional
AVAILABLE HARDWARE/SUPPORT SUBSCRIPTIONS		
Warranty Extension	Optional	Optional
Instant Replacement	Optional	Optional
Premium Support	-	Optional

High Availability (“HA”):

All subscriptions have to be licensed separately for the HA partner. For further information, please contact your local partner or Barracuda Sales at sales@barracuda.com.

Energize Updates

Barracuda Energize Updates help you secure your investment in the ever-changing IT world. Benefit from security updates to patch or repair any security vulnerabilities, keep your Barracuda product up-to-date and fully functional at all times, and get access to our award-winning support.

Energize Updates are available for all SC and CloudGen Firewall models. Monthly subscription; available for up to 5 years. Purchasing at least 12 months of Energize Updates is required with every unit.

Energize Updates includes:

- Enhanced support providing 24x7 technical support via phone, live chat, online portal, and e-mail
- Firmware maintenance including new firmware updates with feature enhancements and bug fixes
- Early release firmware program (optional)
- Unlimited number of client-to-site remote connections
- Security updates to patch/repair any security vulnerabilities
- Regular updates for Application Control database
- IPS signature and pattern updates.

Advanced Threat Protection

Prevent malicious files—even unknown ones—from entering the organization. Avoid network breaches, identify zero-day malware exploits, targeted attacks, advanced persistent threats and other advanced malware that routinely bypass traditional signature based IPS and antivirus engines before they do harm to your network.

Compatibility and Licensing:

Available for all CloudGen Firewall models for up to 5 years. Requires a valid Web Security or Malware Protection subscription.

In case the monthly file capacity is reached, the system stops forwarding files to the ATP cloud for the rest of the current month.

Environment and number of files inspected per month

HARD-WARE	# OF FILES	VIRTUAL	# OF FILES	PUBLIC CLOUD	# OF FILES
F18	108,000	VF10	n/a	Level 2	108,000
F80	108,000	VF25	43,200	Level 4	216,000
F180	108,000	VF50	108,000	Level 6	324,000
F280	216,000	VF100	216,000	Level 8	750,000
F380	260,000	VF250	324,000		
F400	324,000	VF500	432,000		
F600	540,000	VF1000	540,000		
F800	750,000	VF2000	648,000		
F900	1,000,000	VF4000	750,000		
F1000	on request	VF8000	1,000,000		

Malware Protection

The Malware Protection subscription provides gateway-based protection against malware, viruses, spyware, and other unwanted programs inside SMTP/S, HTTP/S, POP3/S, FTP, and SFTP traffic.

Key benefits of Malware Protection:

- Configurable archive recursion depth
- Quarantine functionality for proxy
- Configurable unknown archive policy
- Configurable maximum archive size
- Archiver package support
- Office file-types support
- Proactive detection of new threats
- Advanced heuristics detection techniques
- Hundreds of thousands signatures

Compatibility and Licensing:

Available for all CloudGen Firewall models. The number of protected IPs (capacity) applies.

Monthly subscription; available for up to 5 years.

In High Availability (HA) environments each unit needs to be licensed separately.

Warranty Extension

Provides an extended warranty, and ships a replacement unit on the next business day (best effort) with standard mail upon notification of a failed unit.

Must be purchased within 60 days of hardware purchase and is a continuous subscription from date of activation.
Monthly subscription; available for up to 5 years.

Instant Replacement

One hundred percent uptime is important in corporate environments, but sometimes equipment can fail. In the rare case that a Barracuda product fails, Barracuda ships a replacement unit on the same or next business day. And by means of the Hardware Refresh Program, we ensure that customers benefit from the latest hardware improvements and firmware capabilities:

- Enhanced support providing phone and email support 24/7
- Hard disk replacement on models that have swappable RAID drives
- Free hardware refresh after four years of continuous IR coverage.

Must be purchased within 60 days of hardware purchase and is a continuous subscription from date of activation.
Monthly subscription; available for up to 5 years.

Comparison “Warranty Extension - Instant Replacement”

	WARRANTY EXTENSION	INSTANT REPLACEMENT
Replacement	Next business day (best effort)	Same day or next business day
Shipment	Standard	Express
Hard disk replacement (swappable RAID)	Standard shipping	Standard shipping
Support	Basic Support (with Energize Updates)	Enhanced Support
Available subscriptions	up to 3 years	up to 5 years
Free hardware refresh after 4 years	-	✓

Premium Support

Premium Support ensures that an organisation's network is running at its peak performance by providing the highest level of 24/7 technical support for mission-critical environments. A dedicated Premium Support Account Manager and a team of technical engineers provide fast solutions to high-priority support issues, thereby ensuring that Barracuda Networks equipment maintains continuous uptime.

Key benefits of Premium Support:

- Dedicated phone and email support 24/7
- Priority response time to resolve mission-critical issues
- Priority Level Agreement (PLAs) to guarantee that issues are handled, resolved, and closed quickly
- Dedicated Support Account Manager who is familiar with the customer's environment
- Proactive ticket monitoring and reporting to provide comprehensive information and control

Note:

Available for all CloudGen Firewall models for up to 5 years. For more information on Premium Support please visit www.barracuda.com/support.

Ordering information



Mandatory for each deployment	Mandatory for each deployment	Mandatory for each deployment
Hardware unit	Hardware unit or virtual appliance	Virtual appliance
Pool licence for Energize Updates	Pool SC account (free of charge)	Energize Updates
	Energize Updates	
Optional for each deployment	Optional for each deployment	Optional for each deployment
Instant Replacement	Instant Replacement	Premium Support
Warranty Extension	Warranty Extension	
Spare power supply	Malware Protection	
	Advanced Threat Protection	
	Premium Support	

For ordering information regarding CloudGen Firewall and Firewall Control Center, please refer to the [product overview for CloudGen Firewall](#).

DIN rail compatible appliances

SECURE CONNECTOR 20	SKU
Barracuda Secure Connector FSC20 hardware unit	BNGFSC20A
Pool licence for Energize Updates (monthly)	BNGFSC2p-e<duration>
Instant Replacement (monthly)	BNGFSC20a-h<duration>
Warranty Extension (monthly)	BNGFSC20a-we<duration>
Spare power supply (external)	BNGFSCAPSUa

SECURE CONNECTOR 30	SKU
Barracuda Secure Connector FSC30 hardware unit	BNGFSC30A
Pool licence for Energize Updates (monthly)	BNGFSC3p-e<duration>
Instant Replacement (monthly)	BNGFSC30a-h<duration>
Warranty Extension (monthly)	BNGFSC30a-we<duration>
Spare power supply (external)	BNGFSCAPSUa

SECURE CONNECTOR 21	SKU
Barracuda Secure Connector FSC21 hardware unit	BNGFSC21A
Pool licence for Energize Updates (monthly)	BNGFSC2p-e<duration>
Instant Replacement (monthly)	BNGFSC21a-h<duration>
Warranty Extension (monthly)	BNGFSC21a-we<duration>
Spare power supply (external)	BNGFSCAPSUa

SECURE CONNECTOR 31	SKU
Barracuda Secure Connector FSC31 hardware unit	BNGFSC31A
Pool licence for Energize Updates (monthly)	BNGFSC3p-e<duration>
Instant Replacement (monthly)	BNGFSC31a-h<duration>
Warranty Extension (monthly)	BNGFSC31a-we<duration>
Spare power supply (external)	BNGFSCAPSUa

SECURE CONNECTOR 24 (EMEA / APAC)	SKU
Barracuda Secure Connector FSC24B hardware unit	BNGFSC24B
Pool licence for Energize Updates (monthly)	BNGFSC2p-e<duration>
Instant Replacement (monthly)	BNGFSC24a-h<duration>
Warranty Extension (monthly)	BNGFSC24a-we<duration>
Spare power supply (external)	BNGFSCAPSUa

SECURE CONNECTOR 34	SKU
Barracuda Secure Connector FSC34 hardware unit	BNGFSC34A
Pool licence for Energize Updates (monthly)	BNGFSC3p-e<duration>
Instant Replacement (monthly)	BNGFSC34a-h<duration>
Warranty Extension (monthly)	BNGFSC34a-we<duration>
Spare power supply (external)	BNGFSCAPSUa

SECURE CONNECTOR 25 (EMEA / APAC)	SKU
Barracuda Secure Connector FSC25B hardware unit	BNGFSC25B
Pool licence for Energize Updates (monthly)	BNGFSC2p-e<duration>
Instant Replacement (monthly)	BNGFSC25a-h<duration>
Warranty Extension (monthly)	BNGFSC25a-we<duration>
Spare power supply (external)	BNGFSCAPSUa

SECURE CONNECTOR 35	SKU
Barracuda Secure Connector FSC35 hardware unit	BNGFSC35A
Pool licence for Energize Updates (monthly)	BNGFSC3p-e<duration>
Instant Replacement (monthly)	BNGFSC35a-h<duration>
Warranty Extension (monthly)	BNGFSC35a-we<duration>
Spare power supply (external)	BNGFSCAPSUa

Appendix I - Certificates



CE Declaration of Conformity Barracuda Networks

We,

Manufacturer's Name: Barracuda Networks
Manufacturer's Address: 5225 Hellyer Ave. Suite 150
 San Jose, CA 95138
 USA

Hereby, declare under our sole responsibility that the requirements set out in the Directives 2014/35/EU, 2014/30/EU, 2014/53/2014, 2011/65/EU, 2012/19/EU has been fully fulfilled on our product indication below:

Barracuda Secure Connector

The object of the declaration described above is in conformity with the relevant Union harmonization legislation:

Electrical Safety (LVD) 2014/35/EU
Electromagnetic compatibility directive (EMC) 2014/30/EU
Radio Equipment Directive (RED) 2014/53/EU
Restriction of Hazardous Substances Directive (RoHS) 2011/65/EU
Waste Electrical and Electronic Equipment Directive (WEEE) 2012/19/EU

The following standards and technical specifications have been applied:

EN 55032:2015 + AC:2016 Class A
EN 55024:2010+A1:2015 Class A
EN 61000-3-2:2014 Class A
EN 61000-3-3:2013
EN 300 328 V2.1.1
EN 301 893 V2.1.1
EN 301 489-1 V2.1.1
EN 301 489-52 V1.1.0
EN 301 908-1 V11.1.1
EN 62311:2008
EN 60950-1:2006+A11:2009+A1:2010+A12:2011+A2:2013

Signed for and on behalf of:

Signature, Date, Place :  October 8, 2019, USA
 Name and Job Title : Ken Martin / SVP, World Wide Manufacturing Ops.

Secure Connector FSC20

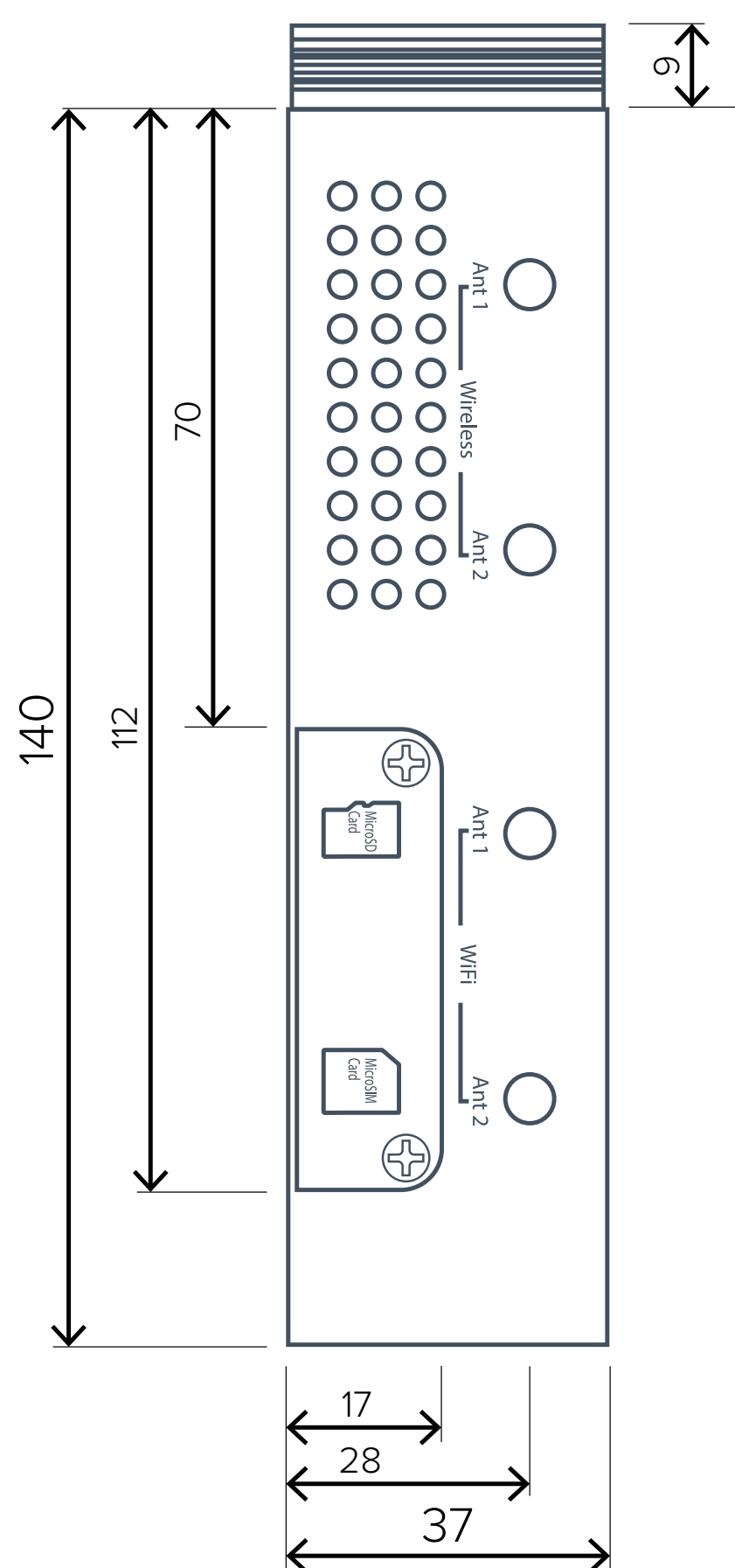
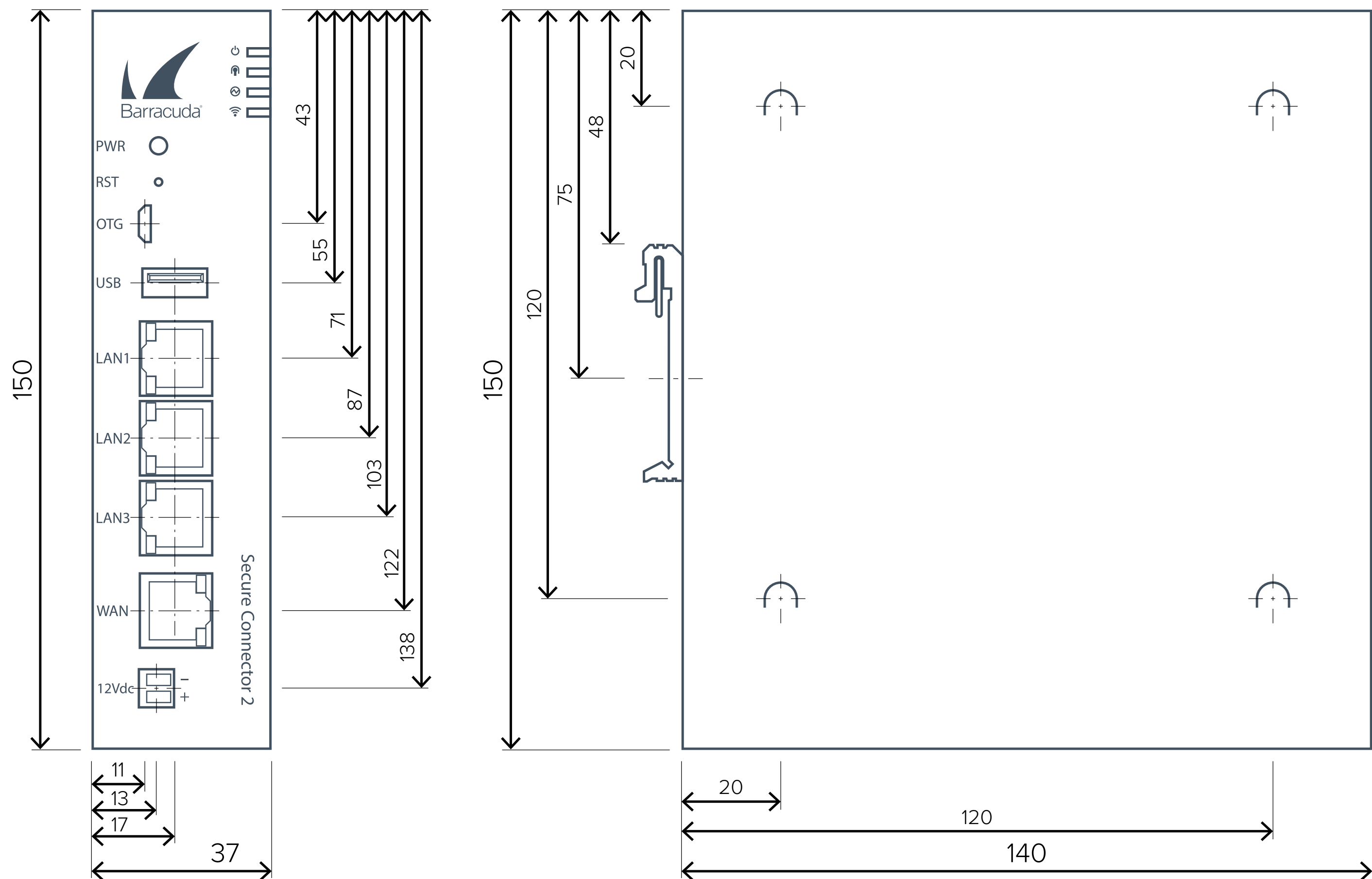

No scale illustration.
All dimensions in mm.

Secure Connector FSC21

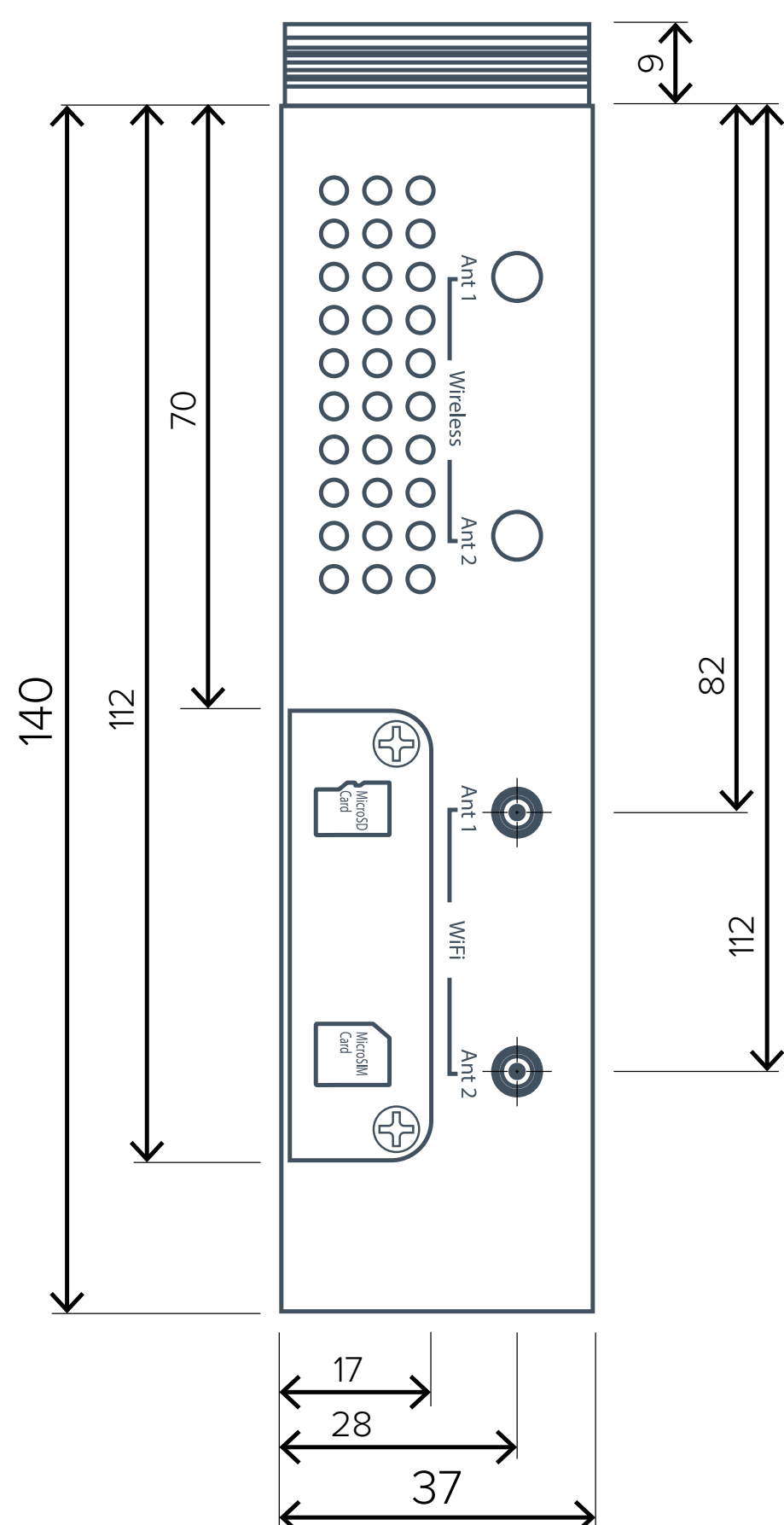
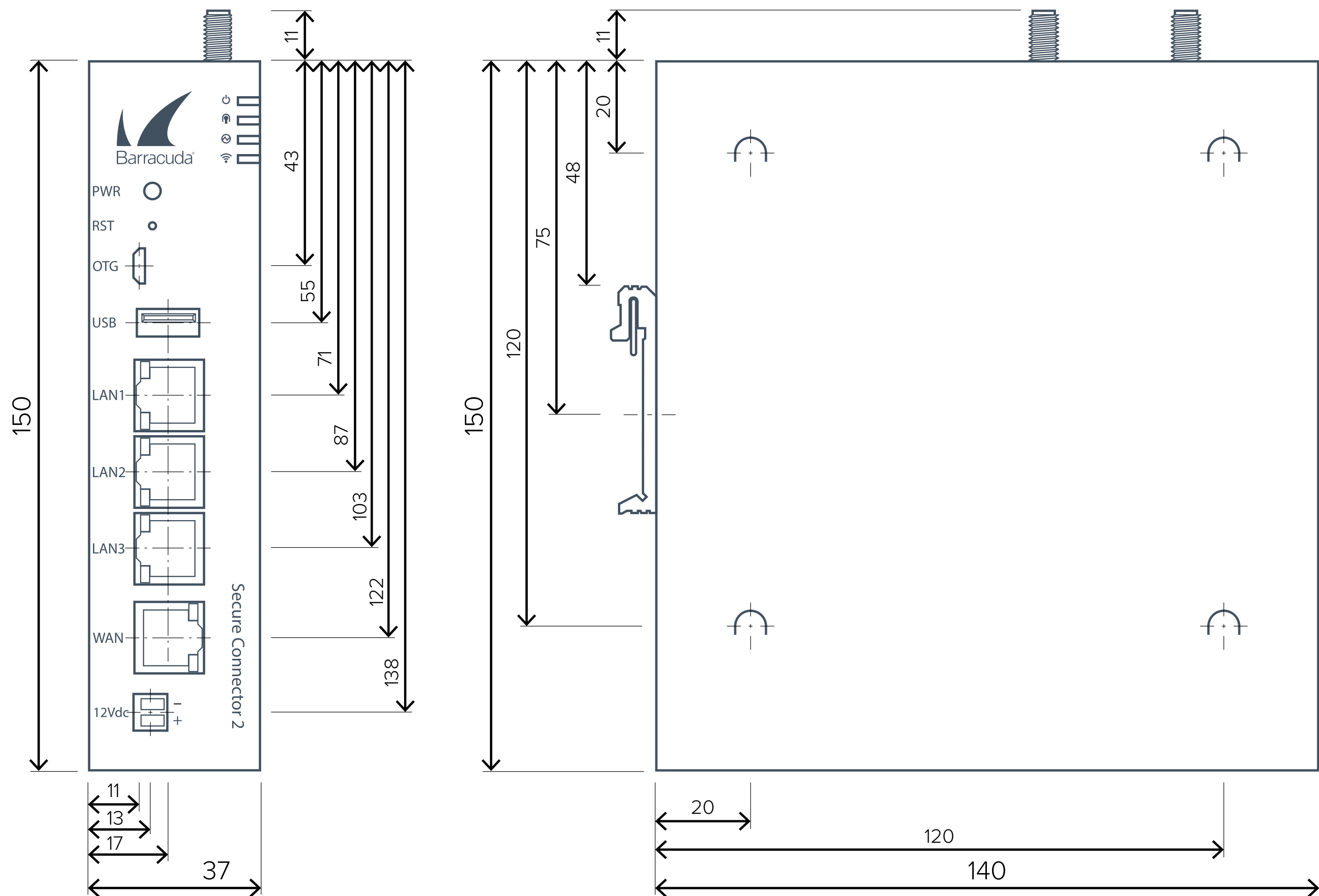

No scale illustration.
All dimensions in mm.

Secure Connector FSC24B

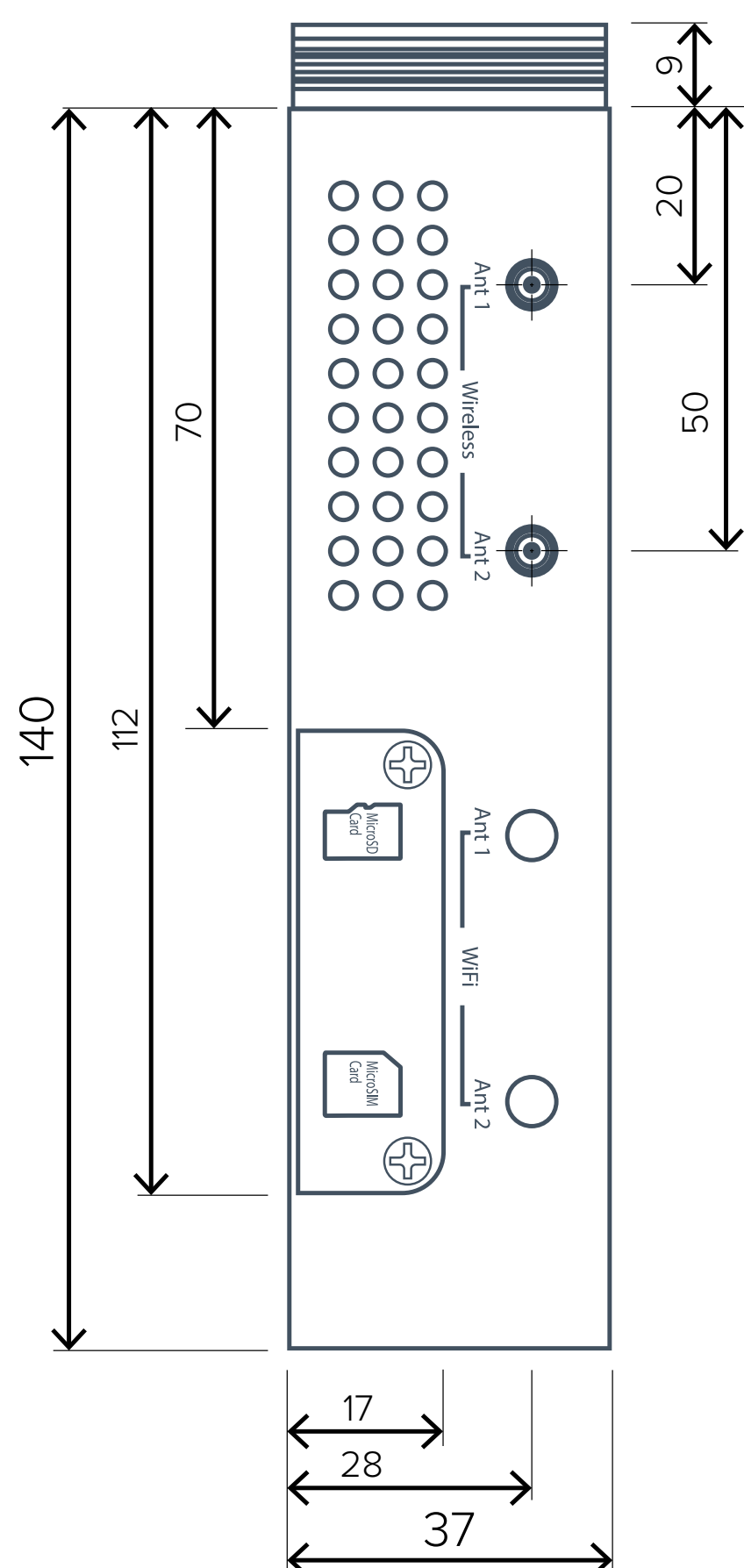
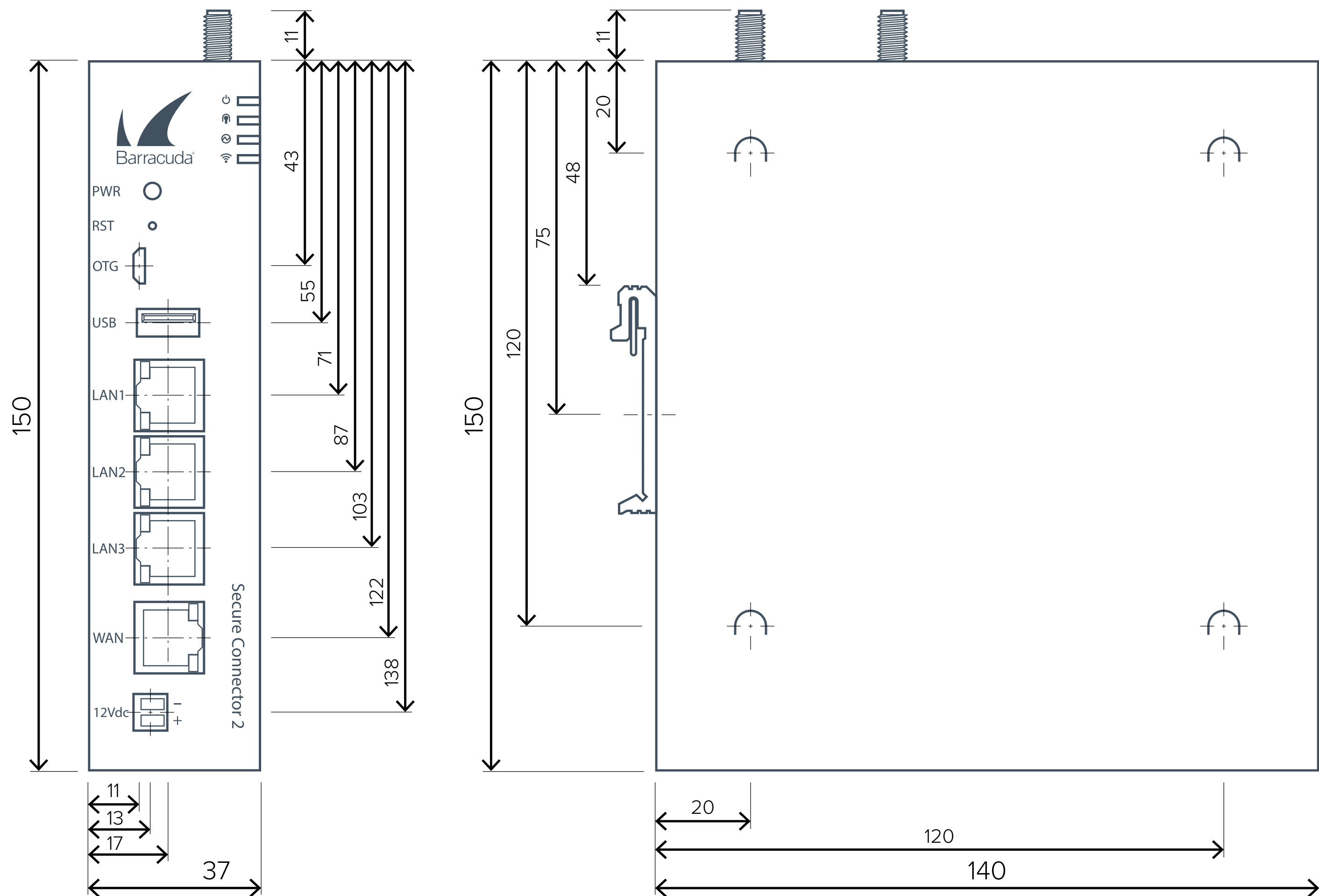

No scale illustration.
All dimensions in mm.

Secure Connector FSC25B

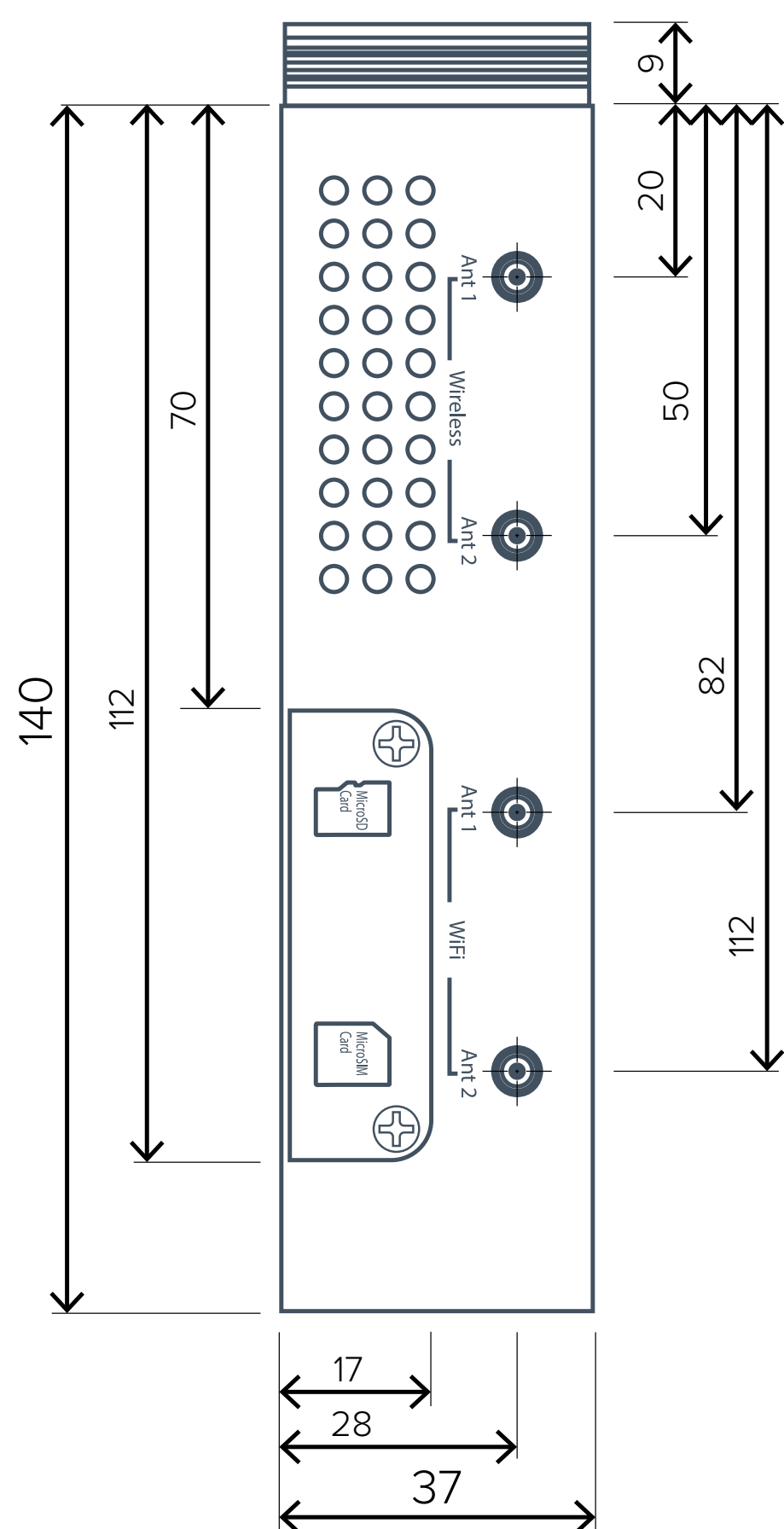
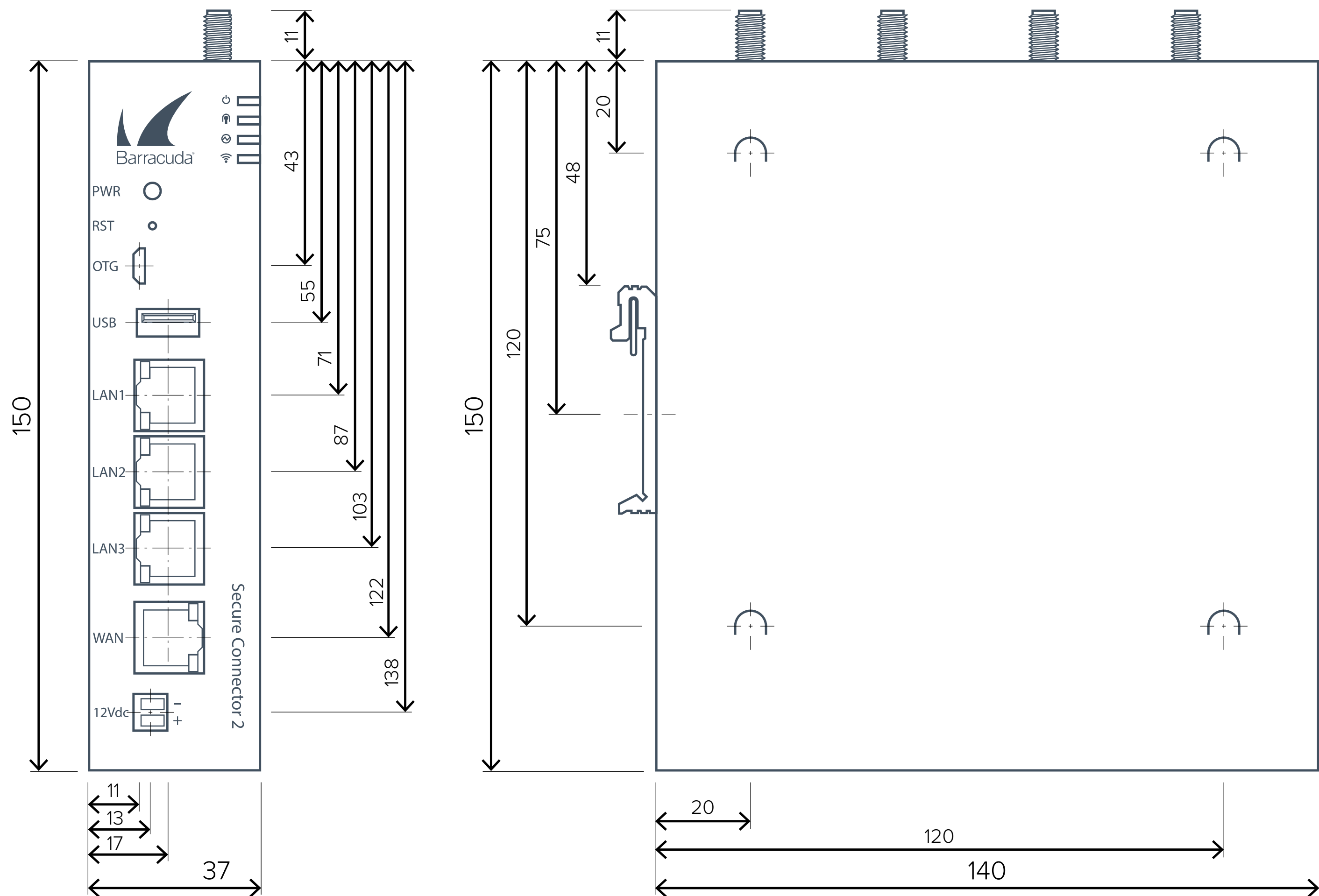

No scale illustration.
All dimensions in mm.

Secure Connector FSC30

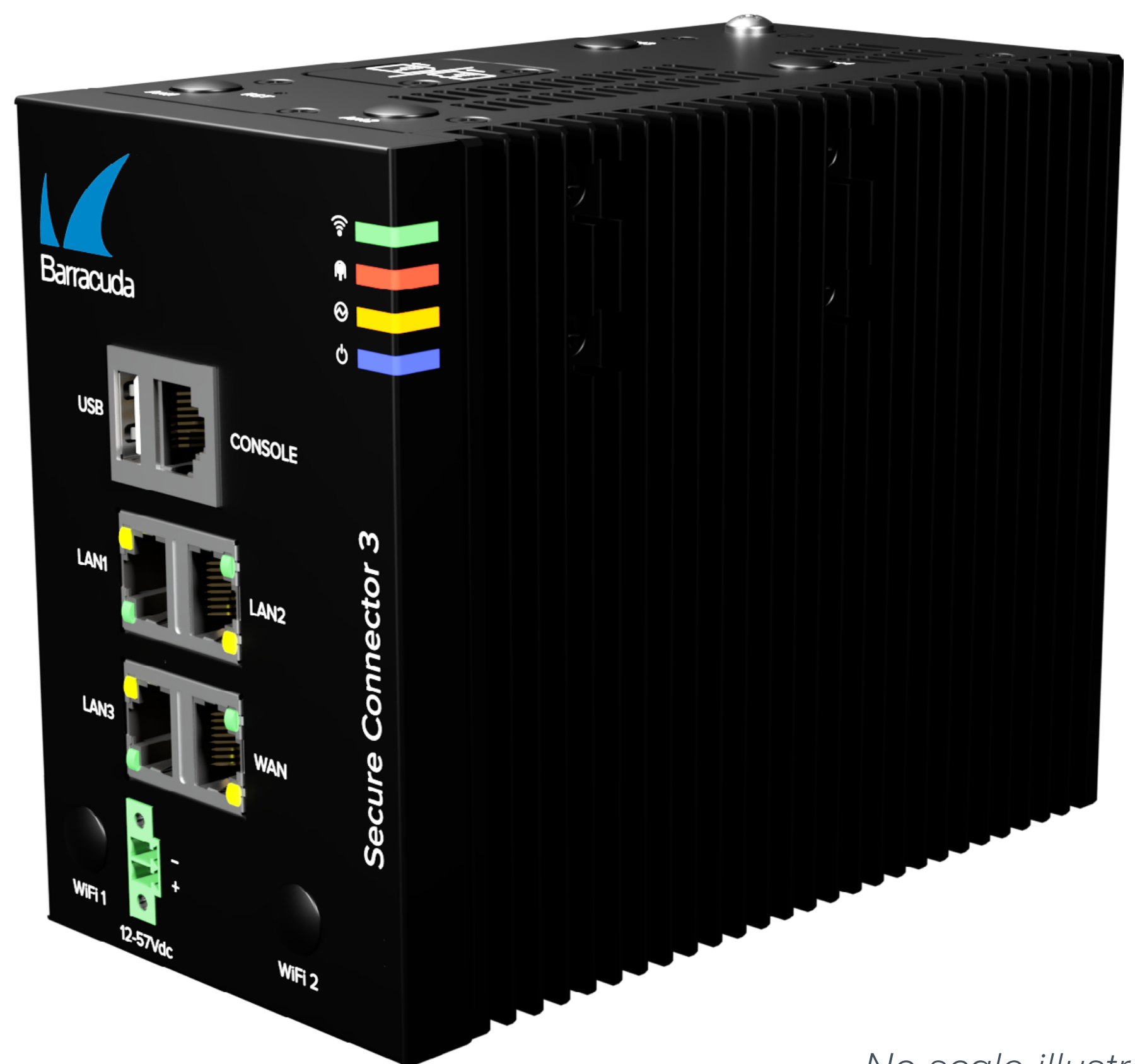
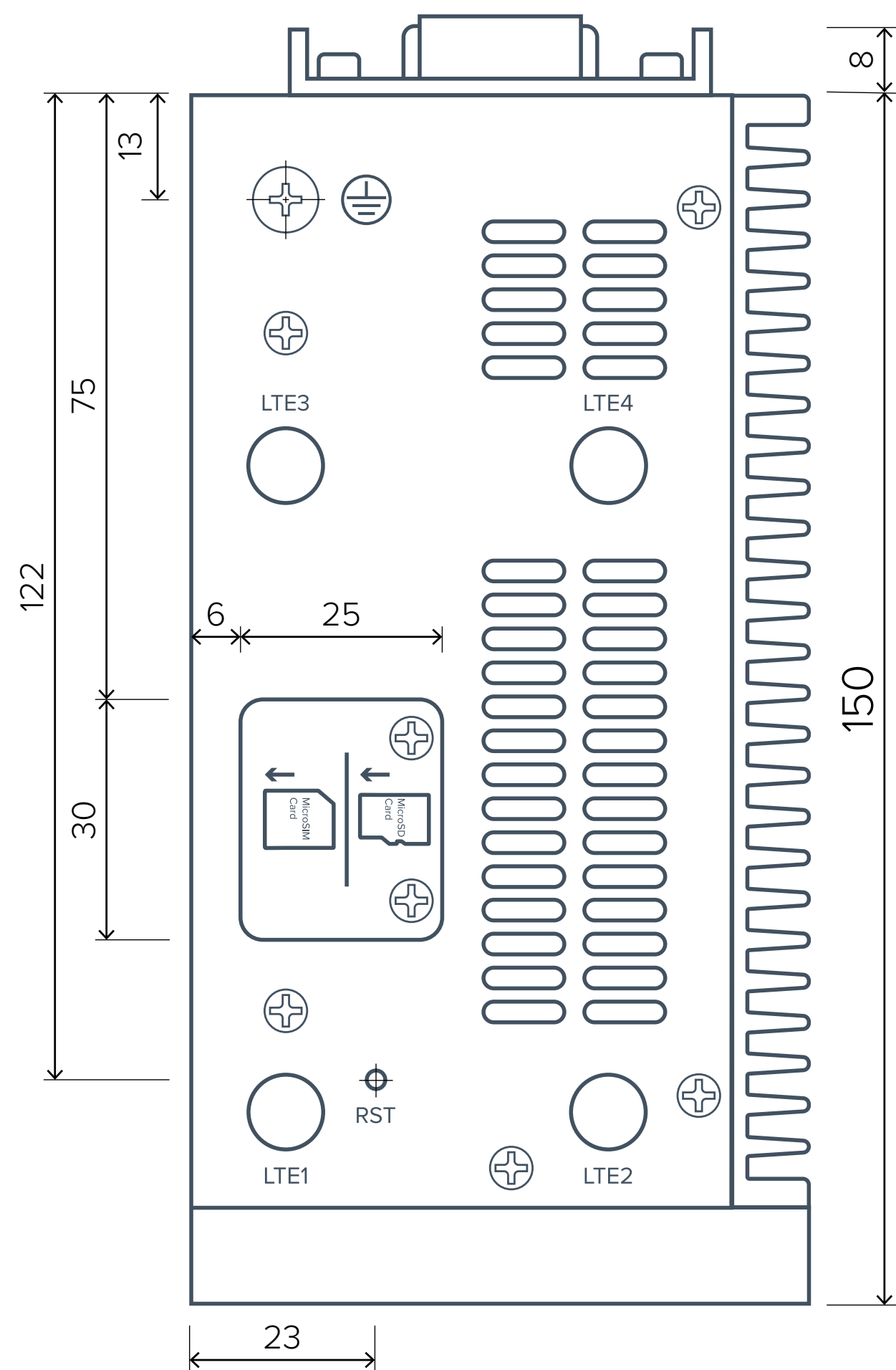
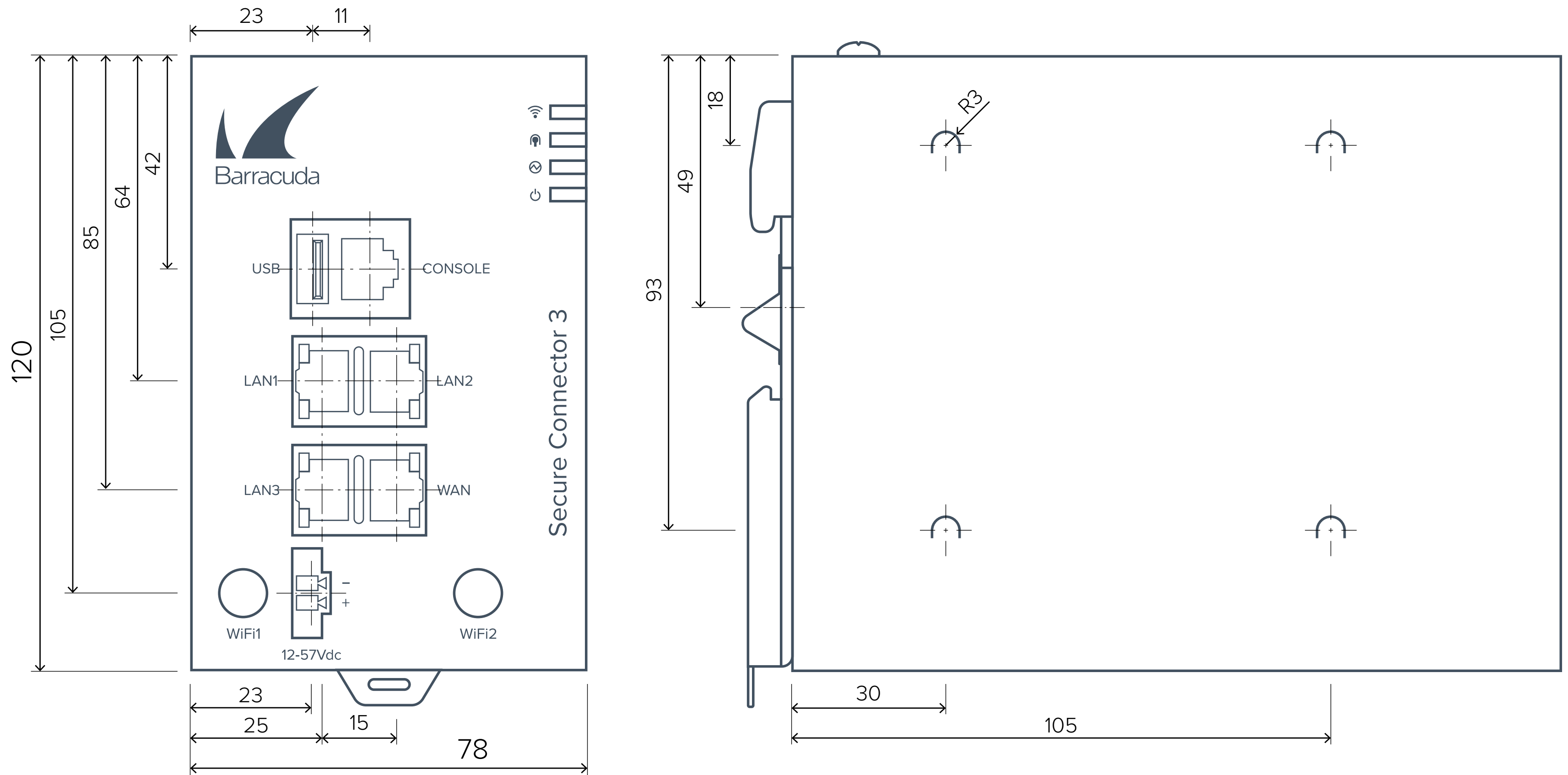

No scale illustration.
All dimensions in mm.

Secure Connector FSC31

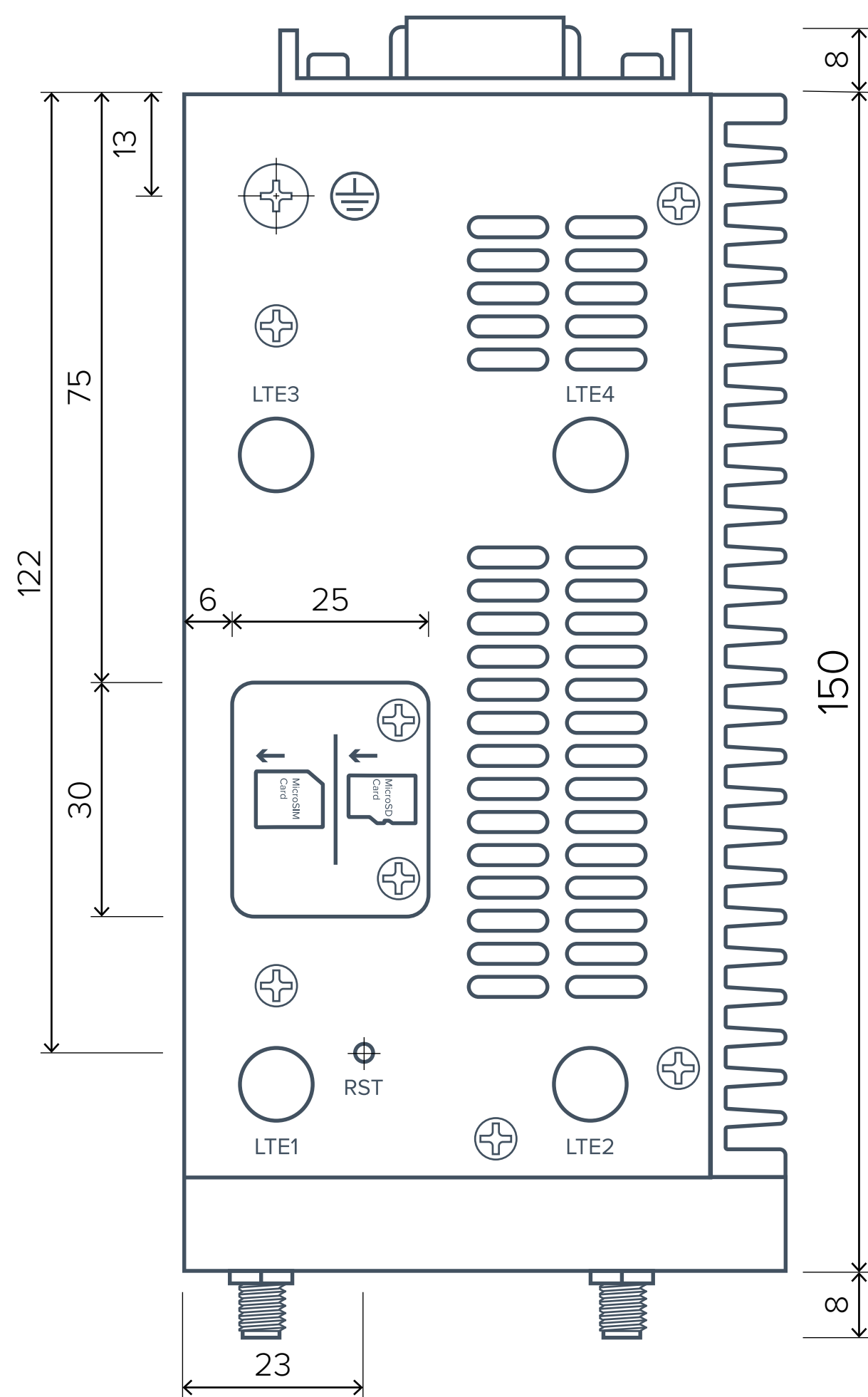
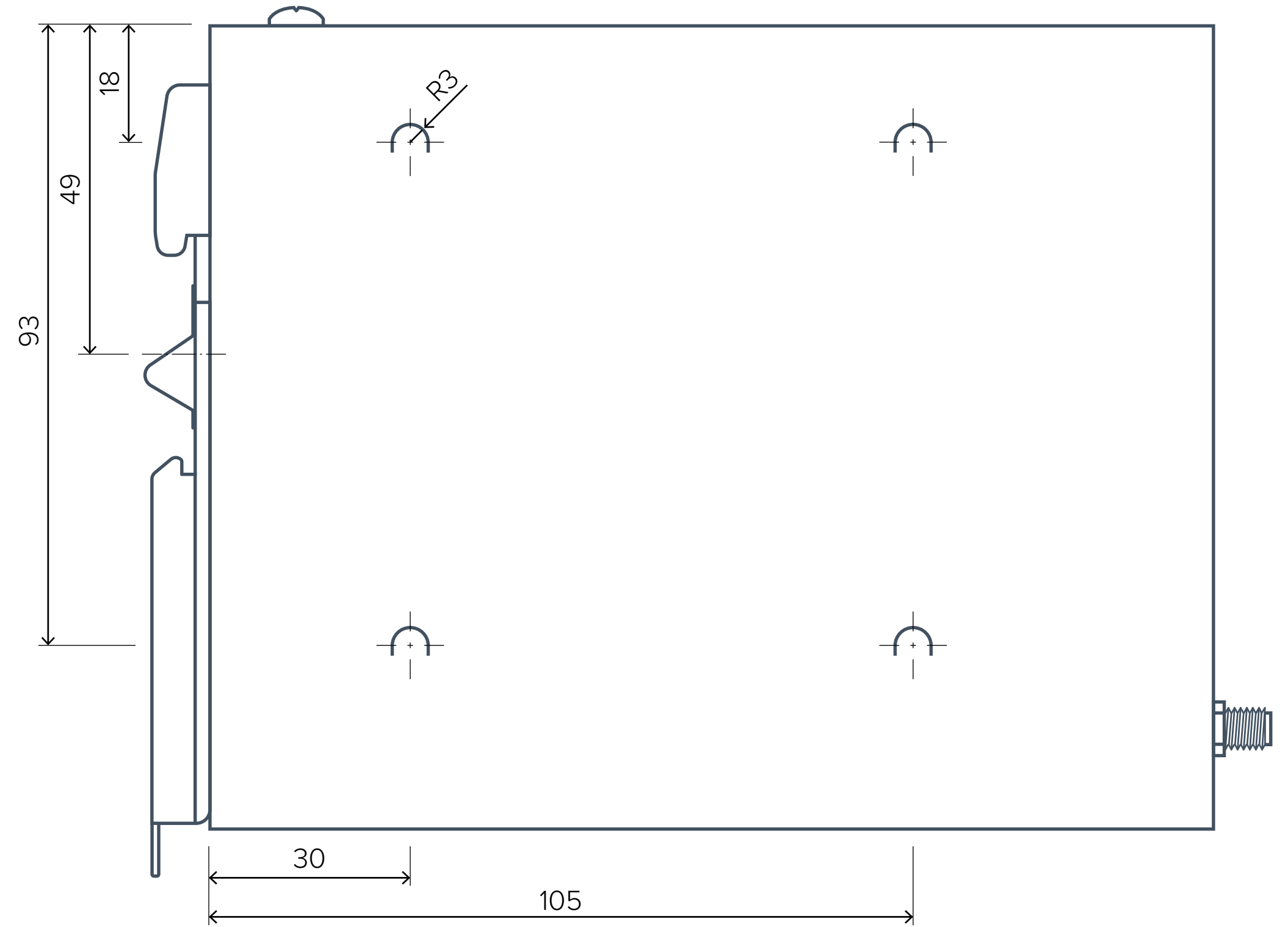
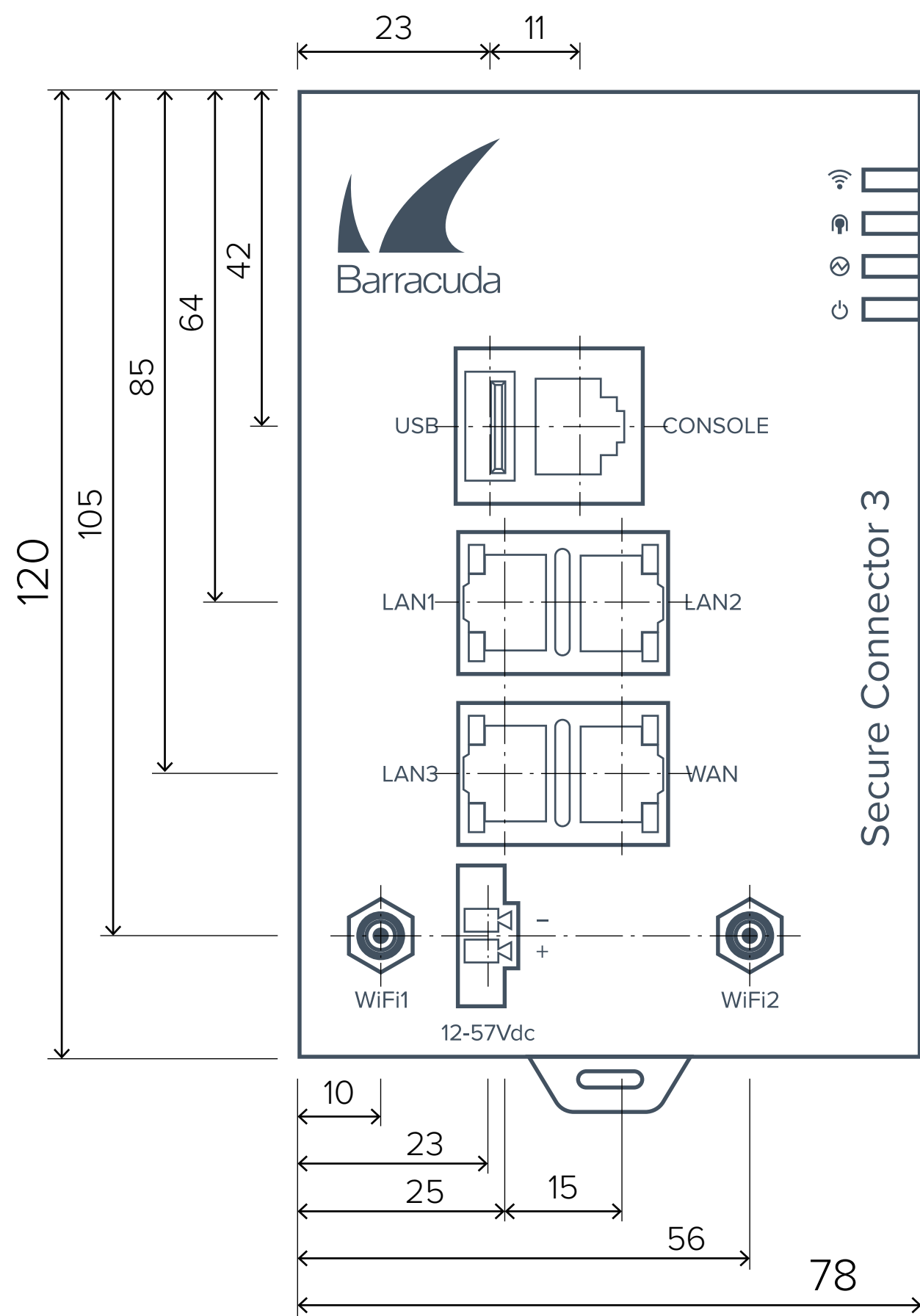

No scale illustration.
All dimensions in mm.

Secure Connector FSC34

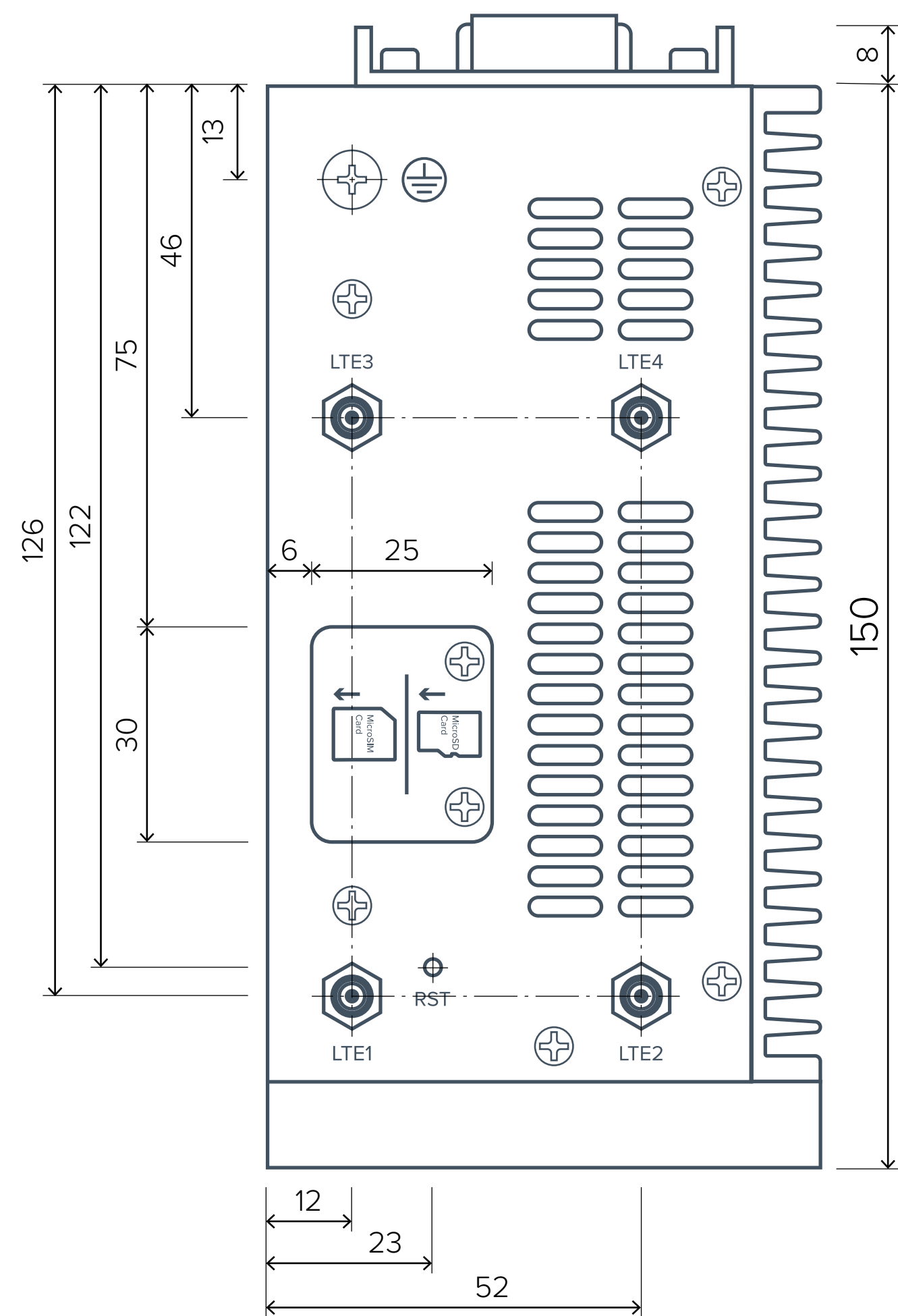
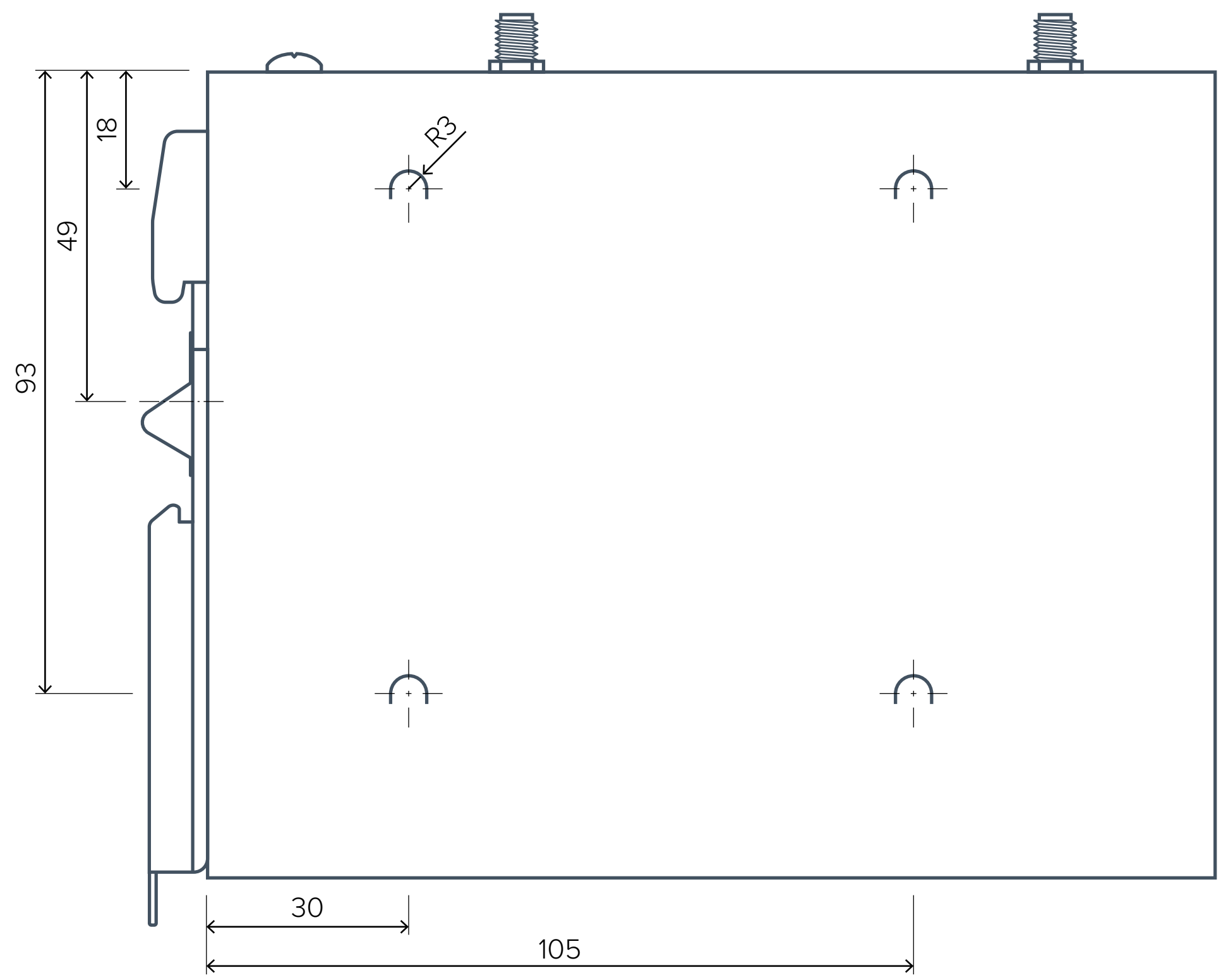
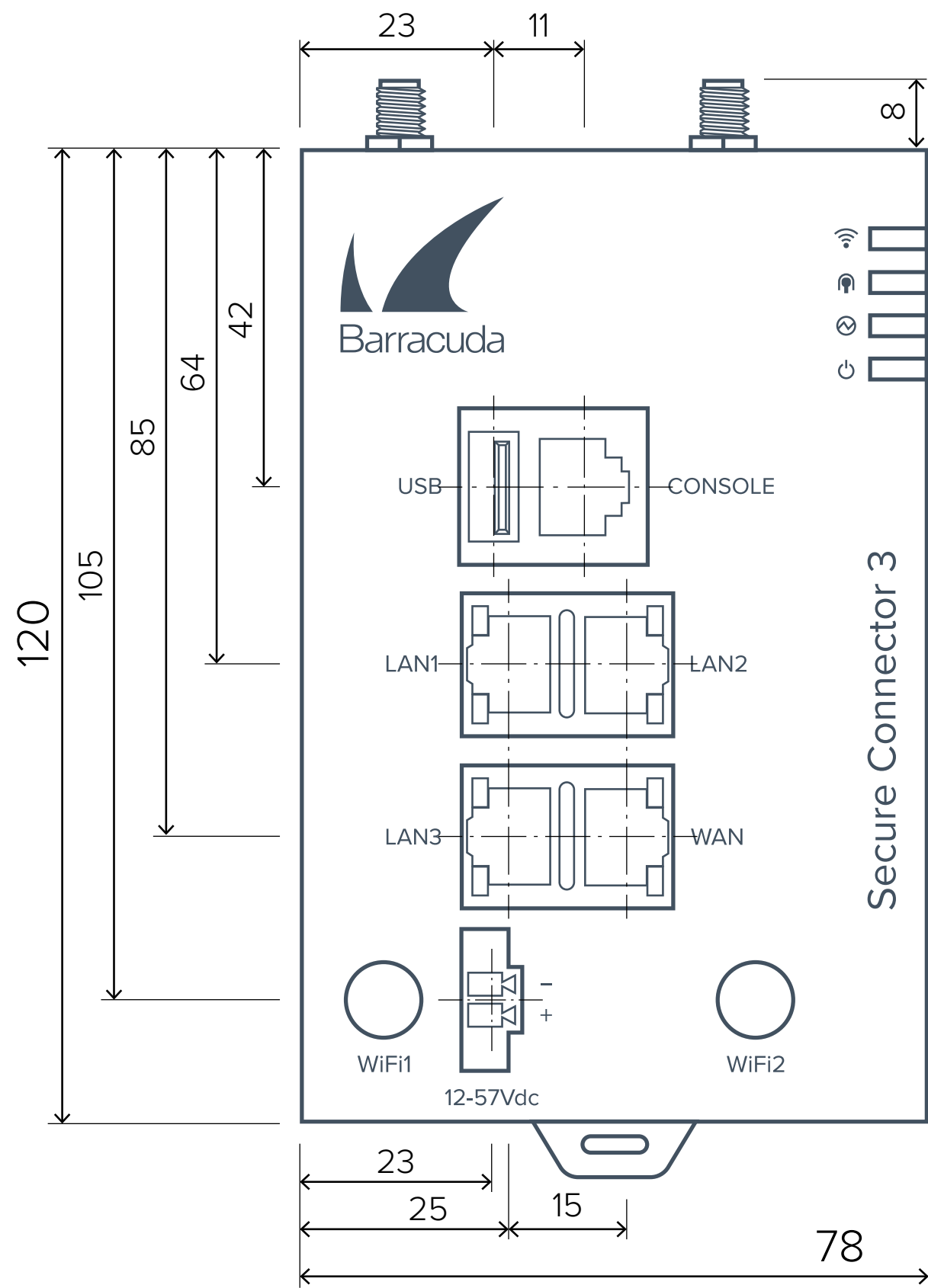

No scale illustration.
All dimensions in mm.

Secure Connector FSC35

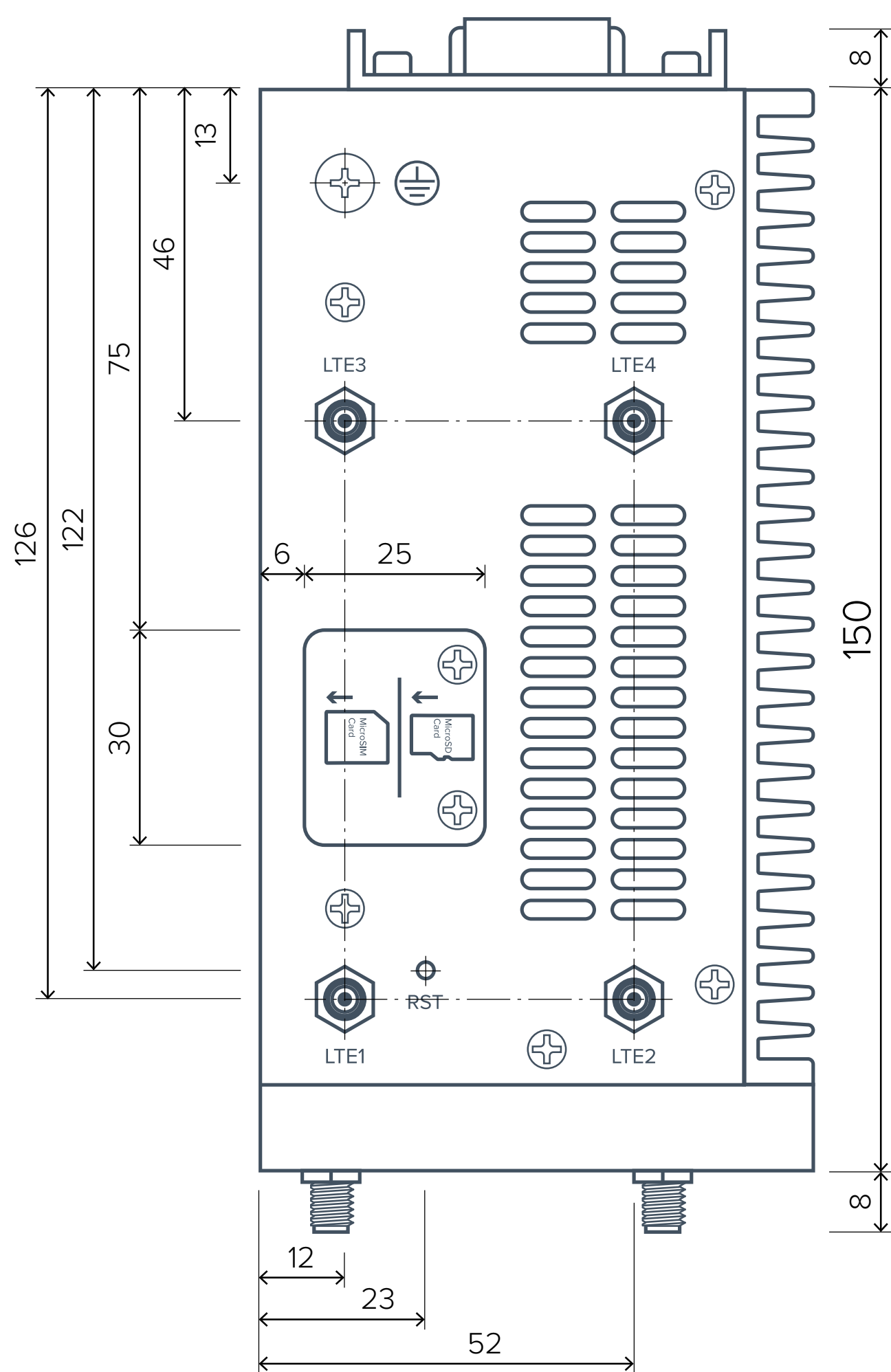
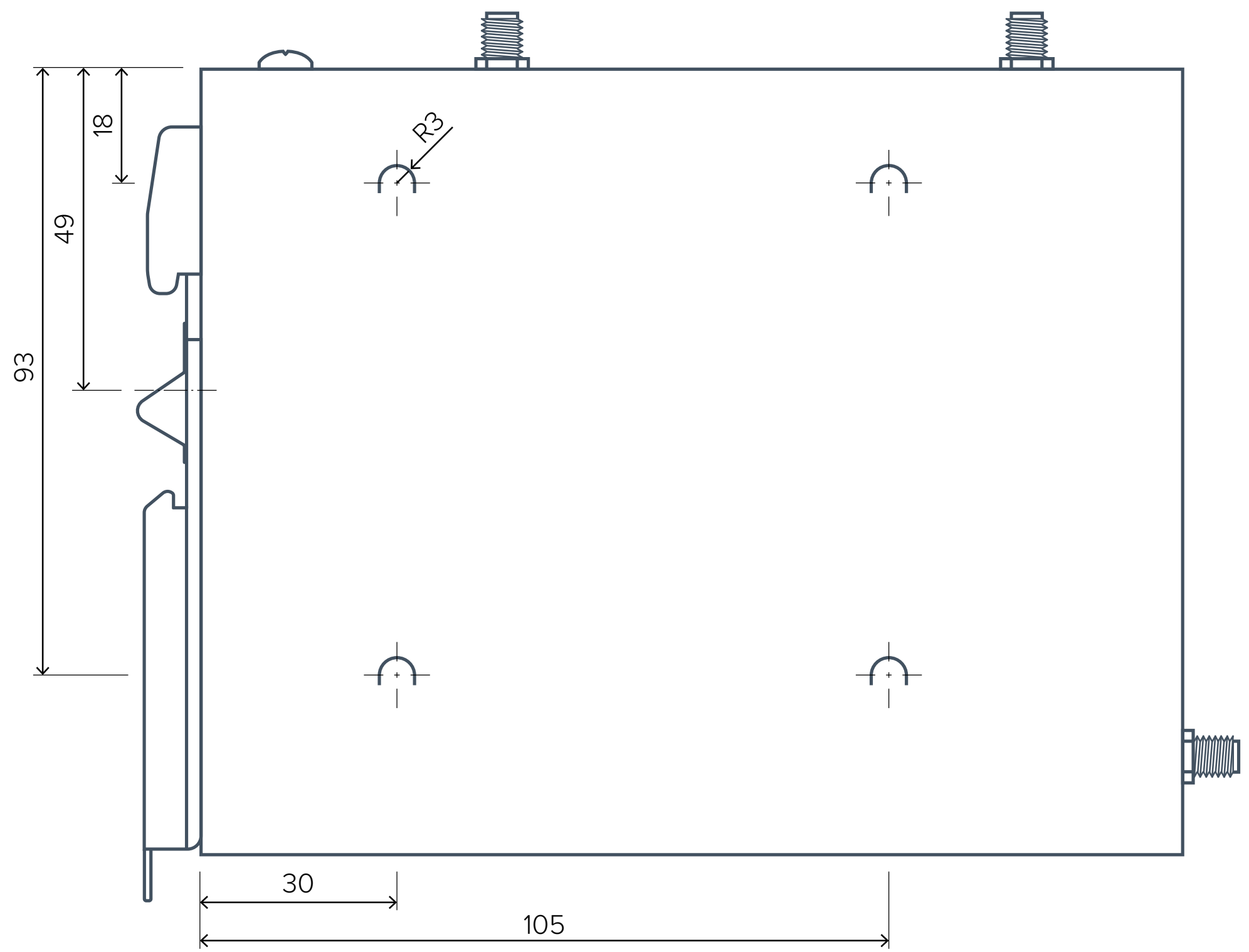
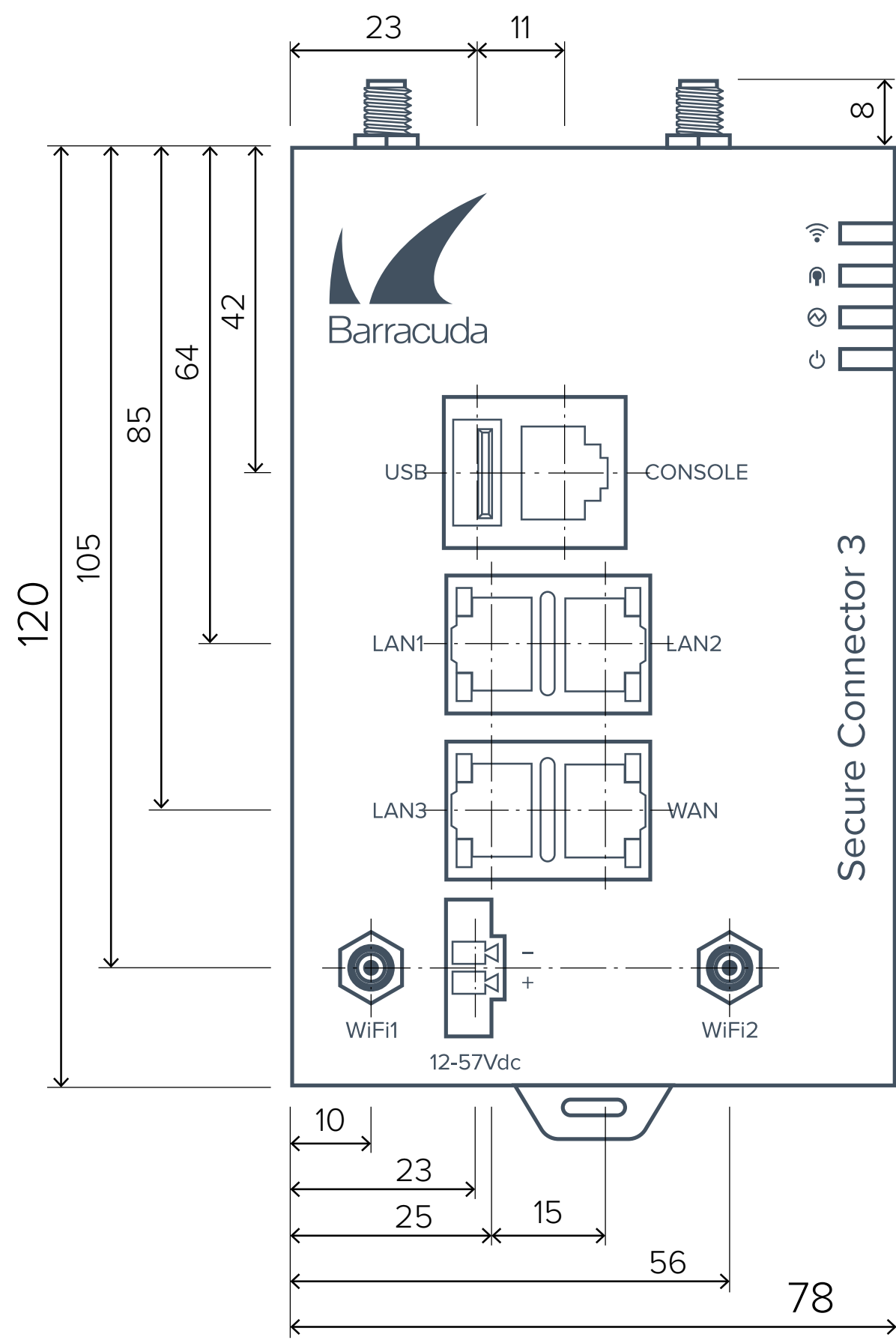

No scale illustration.
All dimensions in mm.

Appendix III - Features and capabilities

BARRACUDA SECURE CONNECTOR AND BARRACUDA CLOUDGEN FIREWALL	
FIREWALL	
Stateful packet forwarding (per rule)	✓
Transparent proxy (TCP; per rule)	✓
Inline graphical packet analyser	✓
NAT (src, dst, nets), PAT	✓
Policy-based NAT (per rule)	✓
Protocol support (IPv4, IPv6 ¹)	✓
IP-less configuration via named networks (IPv4, IPv6)	✓
Wildcard network objects	✓
Gigabit performance	✓
Object oriented rule set	✓
Virtual rule sets	✓
Virtual rule test environment	✓
Realtime connection status	✓
Historical access caches	✓
Event triggered notification	✓
Load balancing for protected servers	✓
Multipath load balancing	✓
Firewall-to-firewall compression (stream & packet compression)	✓
Dynamic rules with timer triggered deactivation (per rule)	✓
Bridging mode / routing mode (mixed)	✓
Virtual IP (proxyARP) support	✓
Transparent IP to user mapping	✓
User authentication	x.509, Microsoft® NTLM, RADIUS, RSA SecurID, LDAP/LDAPS, Microsoft® Active Directory®, TACACS+, local
RPC protocol support (ONC-RPC, DCE-RPC)	✓
VoIP support (H.323, SIP, SCCP (skinny))	✓
Deep inspection of ICS / SCADA protocols	✓
DHCP relaying with packet loop protection & configurable agent-ID policy	✓
Standby mode	Active-Active (with external load balancer only) and Active-Passive
Network notification on failover	✓
Key-based authentication	✓
Encrypted HA communication	✓
Provider/link failover	✓
Transparent failover without session loss	✓

¹ IPv6 firewall forwarding traffic, IPS, and application control - only in conjunction with administration via Barracuda Firewall Admin.

BARRACUDA SECURE CONNECTOR AND BARRACUDA CLOUDGEN FIREWALL

APPLICATION CONTROL

Deep packet inspection	✓
Application behavior analysis	✓
Thousands of applications and protocols supported (Skype, BitTorrent, etc.)	✓
Social media application support (Facebook, Google+, etc.)	✓
Media streaming application support (YouTube, Netflix, etc.)	✓
Proxy and anonymizer detection (Hide Me, Cyberghost, etc.)	✓
SCADA protocol support	✓ (S7, S7+, IEC 60870-5-104, IEC 61850, MODBUS, DNP3)
Application objects based on category, risk, properties, and popularity	✓
Predefined categories such as business, conferencing, instant messaging, media streaming, etc.	✓
Interception of SSL/TLS encrypted traffic	✓
Inspection of SSL/TLS encrypted traffic	✓
Filtering of SSL/TLS encrypted traffic	✓
Creation of customized applications	✓
Deep application context	✓
Google SafeSearch enforcement	✓
Google Accounts enforcement	✓
Application Based Provider Selection	✓
Bandwidth and QoS assignment	✓
Application logging	✓
Application blocking	✓
Application monitor and drill-down function	✓
Reporting	✓

BARRACUDA SECURE CONNECTOR AND BARRACUDA CLOUDGEN FIREWALL

INTRUSION PREVENTION SYSTEM

Inline intrusion prevention	✓
Regular online pattern updates	✓
Packet anomaly protection	✓
Packet reassembly	✓
TCP stream reassembly	✓
TCP checksum check	✓
TCP split handshake protection	✓
TCP stream segmentation check	✓
Generic patten filter	✓
Active ARP handling	✓
Malformed packet check	✓
SMB & NetBIOS evasion protection	✓
HTML decoding	✓
HTML decompression	✓
HTML OBFUSCATION PROTECTION	
UTF-7 character set encoding supported	✓
UTF-16 little-endian encoding supported	✓
UTF-16 big-endian encoding supported	✓
UTF-32 little-endian encoding supported	✓
UTF-32 big-endian encoding supported	✓
Chunked encoding (random chunk size, fixed chunk size)	✓
Deflate compression (RFC 1951)	✓
Gzip compression (RFC1952)	✓
URL OBFUSCATION PROTECTION	
Escape encoding support	✓
Microsoft %u encoding support	✓
Path character transformations and expansions supported	✓
RPC FRAGMENTATION PROTECTION	
MS-RPC (DCE) defragmentation supported (RFC 1151)	✓
SUN-RPC (ONC) defragmentation supported (RFC 1151)	✓
FTP EVASION PROTECTION	
Detection of inserted spaces in FTP command lines	✓
Detection of additional telnet control sequences in FTP commands	✓
DENIAL OF SERVICE, SPOOFING & FLOODING PROTECTION	
IP spoofing protection	✓
Port scan protection	✓
Sniffing protection	✓
SYN/DoS/DDoS attack protection	✓
LAND attack protection	✓
Teardrop / IP fragment attack protection	✓
UDP flood protection	✓
ICMP fragment protection	✓
ICMP flood ping protection	✓
Reverse routing path check	✓
IPS exceptions (allow listing)	✓
IPS EXCEPTIONS BASED ON	
Source / destination	✓
Port & port range	✓
Signature / CVE	✓

BARRACUDA SECURE CONNECTOR AND BARRACUDA CLOUDGEN FIREWALL

MALWARE PROTECTION

Single-pass mode	✓
Proxy mode	✓
Configurable archive recursion depth	✓
Quarantine functionality for proxy	✓
Configurable unknown archive policy	✓
Configurable maximum archive size	✓
Archiver package support	✓
Office file-types support	✓
Proactive detection of new threats	✓
Advanced heuristics detection techniques	✓
Number of signatures	Hundreds of thousands
Frequency of signature updates	Multiple updates per day
Dynamic, on-demand analysis of malware programs (sandbox)	✓

BARRACUDA SECURE CONNECTOR AND BARRACUDA CLOUDGEN FIREWALL

ADVANCED THREAT PROTECTION

Dynamic analysis of documents with embedded exploits (PDF, Office, etc.)	✓
Detailed forensics for both, malware binaries, and web threats (exploits)	✓
High resolution malware analysis (monitoring, execution from the inside)	✓
TypoSquatting and link protection for emails	✓
Support for multiple operating systems (Windows, Android, etc.)	✓
Flexible malware analysis in the cloud	✓

SUPPORTED FILE TYPES

Microsoft executables (exe, msi, dll)	✓
Adobe PDF documents	✓
Android APK files	✓
ZIP archives	✓
RAR archives	✓
macOS executables (dmg)	✓
Microsoft Office (doc, docx, xls, xlsx, ...)	✓
Microsoft Office macro enabled (doc, docx, xls, xlsx, ...)	✓
OpenOffice (odt, ods, ...)	✓
Other archives (7z, lzh, bz, bz2, chm, cab, tar)	✓

SUPPORTED PROTOCOLS

HTTP	✓
HTTPS	✓
FTP	✓
SMTP	✓
SMTPS	✓

BARRACUDA SECURE CONNECTOR AND BARRACUDA CLOUDGEN FIREWALL

WEB FILTER

Block / allow lists (per rule)	✓
Filter categories	95
Number of URLs categorized	>100 million
Alexa top 1 million coverage	> 90%
Temporal constraints	✓
User specific / group specific restrictions	✓
Cached online category database	✓
Local update interval	N/A
Online update interval	continuously

BARRACUDA SECURE CONNECTOR AND BARRACUDA CLOUDGEN FIREWALL

TRAFFIC INTELLIGENCE & SD-WAN

SD-WAN (incl. Traffic shaping inside encrypted tunnels)	✓
Distribution of SD-WAN across up to 24 uplinks	✓
Quality of service (QoS)	✓
Automatic backup uplink activation	✓
Automatic activation of alternate QoS policy upon main WAN failure and backup uplink activation	✓
Dynamic bandwidth and latency detection between peers	✓
Performance-based transport selection	✓
Adaptive bandwidth protection	✓
Adaptive session balancing	✓
Traffic replication	✓
Firewall / encrypted traffic compression	✓
Zero-touch deployment	✓
Data deduplication	✓
Link aggregation	✓
Maximum overall bandwidth per interface	✓
On-the-fly reprioritization via firewall status GUI	✓
Ingress shaping per interface	✓
Application-specific bandwidth assignment	✓
Application-based provider selection	✓
URL-filter-category specific provider selection	✓
Dynamic forward error correction (FEC) for packet loss mitigation	✓

BARRACUDA SECURE CONNECTOR AND BARRACUDA CLOUDGEN FIREWALL

ROUTING & NETWORKING

HA capable with transparent session failover	✓
802.1q VLAN support	✓
xDSL support (PPPoE, PPTP (multi-link))	✓
DHCP client support	✓
ISDN support (EuroISDN (syncppp, rawip))	✓
Link monitoring (DHCP, xDSL, ISDN)	✓
Policy routing support	✓
Ethernet channel bonding	✓
Multiple networks on interface, IP aliases	✓
Multiple provider / WAN link support	✓
Configurable MTU size (per route)	✓
Jumbo frames (up to 9,000 bytes)	✓
IPinIP and GRE tunnels	✓
PPTP	✓
BGP	✓
Virtual routing and forwarding (VFR) instances	✓
Dynamic VPN routing	✓
Dynamic routing (BGP, OSPF, RIP)	✓

BARRACUDA SECURE CONNECTOR AND BARRACUDA CLOUDGEN FIREWALL

REMOTE ACCESS AND SD-WAN

Encryption support	AES-128/256, 3DES/ DES, CAST, Blowfish, Null
Private CA (up to 4,096 bit RSA)	✓
External PKI support	✓
x.509v3 policy extensions (fully recognized)	✓
Certificate revocation (OCSP, CRL)	✓
SD-WAN with traffic intelligence	✓
Dynamic mesh SD-WAN	✓
WAN traffic compression via data deduplication	✓
Star (hub and spoke) SD-WAN network topology	✓
Remote access	✓
Microsoft® domain logon (Pre-logon)	✓
Strong user authentication	✓
Replay protection	✓
NAT traversal	✓
HTTPS and SOCKS proxy compatible	✓
Redundant gateways	✓
Native IPsec for third-party connectivity	✓
PPTP/L2TP (IPsec; remote access clients only)	✓
Dynamic routing (OSPF, BGP) over encrypted connection	✓

BARRACUDA SECURE CONNECTOR AND BARRACUDA CLOUDGEN FIREWALL

SYSTEM MANAGEMENT

Central management	✓
Local management	✓
Comprehensive GUI-based configuration management	✓
Command-line interface (CLI) available	✓
SSH-based access	✓
Multiple administrators	✓
Role-based administrators	✓
Real-time accounting and visualization	✓
Easy roll-out and recovery	✓
USB installation and recovery	✓
Zero-touch deployment	-
Full life-cycle management	✓
In-band management	✓
Dedicated management interface	✓
Serial interfaces	✓
Central management interface	✓
All management via VPN tunnel	✓

BARRACUDA SECURE CONNECTOR AND BARRACUDA CLOUDGEN FIREWALL

LOGGING/MONITORING/ACCOUNTING

System health, activity monitoring	✓
Human readable log files	✓
Statistics	-
Active event notification	Email/SNMP trap
Real-time accounting and reporting	✓
Syslog streaming (fully GUI configurable)	✓

ADVANCED REMOTE ACCESS		
REMOTE ACCESS & NETWORK ACCESS CLIENTS	REMOTE ACCESS CLIENT	NETWORK ACCESS CLIENT
ARCHITECTURE		
Integrated client	✓	✓
Integrated health agent & managed personal firewall	-	✓
Full NAC policy support	-	✓
Customizable user interface	✓	✓
Low power consumption network stack	✓	✓
SUPPORTED OS VARIANTS		
Microsoft Windows Vista (32-bit, 64-bit)	✓	✓
Microsoft Windows 7 (32-bit, 64-bit)	✓	✓
Microsoft Windows 8 (32-bit, 64-bit)	✓	✓
Microsoft Windows 10 (32-bit, 64-bit)	✓	✓
Linux (kernel 2.4, kernel 2.6)	✓	-
macOS (10.5, 10.6, 10.7, 10.8, 10.9, 10.10, 10.11)	✓	-
MANAGEMENT		
Central management of configuration	✓	✓
Diagnostics log and report	✓	✓
Status monitoring	✓	✓
Attack access cache	✓	✓
Packet log (capture)	✓	✓
Groups	✓	✓
Silent client setup	✓	✓
Password protection of settings ^{2,3}	✓	✓
AUTHENTICATION SUPPORT		
Time-based one-time password (TOPT) support	✓	✓
Microsoft® Certificate Management (Crypto API)	✓ ²	✓
Microsoft® Active Directory ⁴	✓ ²	✓
LDAP ⁴	✓	✓
RADIUS ⁴	✓	✓
MSNT ⁴	✓ ²	✓
RSAACE ⁴	✓	✓
Azure AD	✓	✓
External X509 certificates	✓	✓
SMS PASSCODE ⁴	✓	✓
RSA tokens ⁴	✓	✓
Smart cards ⁵	✓ ²	✓
Microsoft domain logon support (prelogon)	✓ ²	✓
PERSONAL FIREWALL CAPABILITIES		
Dynamic adapter object & user object handling	✓	✓
RPC handling	✓	✓
Multiple rule sets support	✓	✓
Client side policy enforcement	✓	✓
Application control	✓	✓
Adapter control	✓	✓
User context enforcement	✓	✓
NetBIOS protection	✓	✓
DoS attack protection	✓	✓
Executable scripts	✓	✓

² Only for Microsoft operating systems.

³ Also prevents changes to client settings by users with administrator rights.

⁴ Queried by Barracuda SAC VPN server on behalf of client.

⁵ For manufacturer with Microsoft Crypto Service Provider

ADVANCED REMOTE ACCESS CUDALAUNCH & SSL VPN	CUDALAUNCH				BROWSER-BASED SSL VPN
	WINDOWS	MACOS	IOS	ANDROID	
Access to web apps (reverse proxied internal apps)	✓	✓	✓	✓	✓
Access to tunnel web apps (internal apps via SSL tunnel)	✓	✓	✓	✓	✓
RDP (via SSL tunnel)	✓	✓	✓	✓	-
SSL tunnels for native client apps	✓	✓	✓	✓	-
IP remote access connections (connect device to network)	TINA protocol	-	IPsec	TINA protocol	-
Built-in demo setup	✓	✓	✓	✓	-
Central administration via CloudGen Firewall and Firewall Admin	✓	✓	✓	✓	✓
Automatic self-configuration and management of remote access connections	✓	✓	✓	✓	✓
Integration with CloudGen Firewall User Authentication	✓	✓	✓	✓	-
Access policies utilizing multi-factor and multi-policy authentication	✓	✓	✓	✓	✓
Client certificate authentication	✓	✓	✓	✓	✓
Single sign-on to internal apps	✓	✓	✓	✓	✓
Launchpad favorites (apps or remote access connections)	✓	✓	✓	✓	-
User attributes (ability for end users to edit)	✓	✓	✓	✓	✓
Dynamic firewall rule control (for system administrators)	✓	✓	✓	✓	-
Custom help or info text for your organization	✓	✓	✓	✓	✓
Manually edit and create IP remote access connections	✓	✓	✓	✓	✓
Debug log for easy support	✓	✓	✓	✓	✓
Multi-factor authentication (up to 6 schemes)	✓	✓	✓	✓	-
Debug log for easy support	✓	✓	✓	✓	-

BARRACUDA FIREWALL CONTROL CENTER CONFIGURATION MANAGEMENT	STANDARD EDITION (VC400 / VCC400)	ENTERPRISE EDITION (VC610 / VCC610)	GLOBAL EDITION (VC820)
	Tenants	1	1 ⁶
Configuration groups ⁷	1	Unlimited	Unlimited
Maximum managed gateways [recommended]	Unlimited [20]	Unlimited [200]	Unlimited [1000+ depends on HW]
Configuration templates (repositories)	✓	✓	✓
Shared configuration data	✓	✓	✓
Zero-touch deployment	✓	✓	✓
Operating system parameters	✓	✓	✓
Networking/routing parameters	✓	✓	✓
FW/remote access policies, application gateway parameters	✓	✓	✓
Flat file data storage	✓	✓	✓
Database characteristics (transaction orientation, locking, etc.)	✓	✓	✓
Backup and restore functionality	✓	✓	✓
Gateway configuration archive for speed install	✓	✓	✓
Configuration update monitoring	✓	✓	✓
Full RCS versioning	✓	✓	✓
VPN graphical tunnel interface	✓	✓	✓
Dynamic mesh site-to-site VPN support	✓	✓	✓
Barracuda Network Access Client policy management	✓	✓	✓
Multi-release management	-	✓	-
Multi-platform management	✓	✓	-

⁶ The public cloud edition VCC610 supports two tenants.

⁷ "Configuration Groups" ("cluster" in the firmware) refers to an administratively bundled group of devices and not to a load sharing cluster.

BARRACUDA FIREWALL CONTROL CENTER STATUS MONITORING	STANDARD EDITION (VC400 / VCC400)	ENTERPRISE EDITION (VC610 / VCC610)	GLOBAL EDITION (VC820)
Gateway health state	✓	✓	✓
Launch pad functionality	✓	✓	✓
Customizable layout	✓	✓	✓
Barracuda Earth support	-	✓	✓

BARRACUDA FIREWALL CONTROL CENTER TRUST CENTER	STANDARD EDITION (VC400 / VCC400)	ENTERPRISE EDITION (VC610 / VCC610)	GLOBAL EDITION (VC820)
Gateway x.509 certificate CA	✓	✓	✓
Gateway SSH key management	✓	✓	✓
VPN server for management tunnels to gateways	✓	✓	✓
Virtual IP addresses for gateways (ProxyARP)	✓	✓	✓
Dynamic gateway IP address support	✓	✓	✓

BARRACUDA FIREWALL CONTROL CENTER LICENSE CENTER	STANDARD EDITION (VC400 / VCC400)	ENTERPRISE EDITION (VC610 / VCC610)	GLOBAL EDITION (VC820)
License timestamp server	✓	✓	✓
License status display	✓	✓	✓
Central event message list	✓	✓	✓
Event forwarding (SNMP, mail)	✓	✓	✓
Event log	✓	✓	✓

BARRACUDA FIREWALL CONTROL CENTER CENTRAL SOFTWARE UPDATE	STANDARD EDITION (VC400 / VCC400)	ENTERPRISE EDITION (VC610 / VCC610)	GLOBAL EDITION (VC820)
Real-time version display	✓	✓	✓
Kernel and OS updates	✓	✓	✓
Firmware updates & log viewer	✓	✓	✓

BARRACUDA FIREWALL CONTROL CENTER SECURE REMOTE EXEC. ENVIRONMENT (SSHV2)	STANDARD EDITION (VC400 / VCC400)	ENTERPRISE EDITION (VC610 / VCC610)	GLOBAL EDITION (VC820)
Job scheduling	✓	✓	✓
Script management	✓	✓	✓
Execution log viewer	✓	✓	✓

BARRACUDA FIREWALL CONTROL CENTER ADMINISTRATIVE MODEL	STANDARD EDITION (VC400 / VCC400)	ENTERPRISE EDITION (VC610 / VCC610)	GLOBAL EDITION (VC820)
Fully GUI-based access (Barracuda Firewall Admin management tool)	✓	✓	✓
Strong authentication & AES encryption	✓	✓	✓
Configurable role-based administration	✓	✓	✓
Adjustable view on configuration tree	✓	✓	✓
Configurable administrative domains	-	✓	✓
Multiple domains per administrator	-	✓	✓
Configurable access on OS level	✓	✓	✓
Configurable access notification	✓	✓	✓

BARRACUDA FIREWALL CONTROL CENTER REPORTING AND ACCOUNTING	STANDARD EDITION (VC400 / VCC400)	ENTERPRISE EDITION (VC610 / VCC610)	GLOBAL EDITION (VC820)
Historical reports on gateway activity	✓	✓	✓
Customer-based gateway activity reports	✓	✓	✓
Policy distribution	✓	✓	✓
Control Center resource utilization	✓	✓	✓
Gateway-resource utilization	✓	✓	✓
Central log host	✓	✓	✓
Streaming/relaying to external log host	✓	✓	✓
Barracuda Report Server integration	✓	✓	✓

BARRACUDA FIREWALL CONTROL CENTER ADDITIONAL FUNCTIONS	STANDARD EDITION (VC400 / VCC400)	ENTERPRISE EDITION (VC610 / VCC610)	GLOBAL EDITION (VC820)
NTP4 time server for gateways	✓	✓	✓
Integrated DNS server	✓	✓	✓
High availability	Optional	Optional	HA license included
SIEM syslog interface	✓	✓	✓
Public key infrastructure	-	✓	✓
Revision control system	✓	✓	✓
Access monitor	✓	✓	✓

Appendix IV - Useful links

- Barracuda Campus for online trainings and knowledge datenbase:
<https://campus.barracuda.com>
- Detailed information on Energize Updates subscription:
<https://www.barracuda.com/support/updates>
- Online application explorer including list of supported protocols:
<https://campus.barracuda.com/product/cloudgenfirewall/browse/application-explorer>
- Product information portal
<https://campus.barracuda.com/doc/91980633/>
- End-of-Support (EoS) / End-of-Life (EoL) for hardware
<https://campus.barracuda.com/doc/71860841/>
- End-of-Support (EoS) for firmware
<https://campus.barracuda.com/doc/71860849/>
- GDPR statement
<https://www.barracuda.com/company/legal/gdpr>



Document version 3.3
Applies for firmware version 8.3.x

Barracuda Networks, Inc.
barracuda.com